

Valvole a farfalla
Butterfly valves



ZVF

VVF

ZVF



DATI TECNICI STRUTTURA VALVOLA

STRUTTURA VALVOLA		
Conessioni da DN10 a DN150	DIN, SMS, IDF, BS (RJT), Clamp, Flangia	Altre connessioni a richiesta
Materiale a contatto con il prodotto	AISI 316L (1.4404)	Altro materiale a richiesta
Materiale guarnizioni a contatto con il prodotto (omologazione FDA)	EPDM, FKM, HNBR, MVQ	Altro materiale a richiesta
Temperatura massima prodotto (EPDM applicazioni con aria)	120 °C (248 °F)	Per temperature diverse contattare Bardiani Valvole
Temperatura minima prodotto (EPDM applicazioni con aria)	-10 °C (14 °F)	
Pressione massima prodotto	10 bar (145 psi)	
Pressione massima di tenuta	10 bar (145 psi)	
Finitura superficiale materiale a contatto con il prodotto	Ra 0.8 µm (altri tipi di finitura a richiesta)	
STRUTTURA ATTUATORE PNEUMATICO		
Attacchi aria	1/8" (BSP) per tubo 6x4mm	
Pressione	Da 6 bar (87 psi) a 8 bar (116 psi)	
Materiale cilindro	AISI 304 (1.4301)	
Materiale guarnizioni	NBR	
COMANDO MANUALE		
Materiale maniglia	Plastica (PA6 GF30)	AISI 304 (1.4301) su richiesta

VVF



TECHNICAL DETAILS

VALVE STRUCTURE		
Connections from DN10 to DN150	DIN, SMS, IDF, BS (RJT), Clamp, Flange	Other connections on request
Material in contact with the product	AISI 316L (1.4404)	Other material on request
Material gaskets in contact with the product (FDA homologation)	EPDM, FKM, HNBR	Other material on request
Max product temperature (EPDM applications with air)	120 °C (248 °F)	For other temperature, please ask Bardiani Valvole
Min product temperature (EPDM applications with air)	-10 °C (14 °F)	
Max. product pressure	10 bar (145 psi)	
Max. working pressure	10 bar (145 psi)	
Finish on surfaces in contact with the product	Ra 0.8 µm (other types of surface finish on request).	
PNEUMATIC ACTUATOR STRUCTURE		
Air connectors	1/8" (BSP) for pipe 6x4mm	
Air pressure	From 6 bar (87psi) to 8 bar (116psi)	
Cylinder material	AISI 304 (1.4301)	
Gasket material	NBR	
HAND CONTROL		
Handle material	Plastic (PA6 GF30)	AISI 304 (1.4301) on request

CERTIFICAZIONI
CERTIFICATIONS



Attacco WAFER4

Disponibile sia nella versione pneumatica ZVF che manuale VVF, l'attacco Wafer4 consente di semplificare lo smontaggio del corpo valvola con la sola rimozione di 2 viti lasciando in linea le tubazioni durante le operazioni di manutenzione.

WAFER4 connection

Available in both ZVF and VVF version, this particular type of connection fittings allow to pull off easily the valve body from the piping only removing 2 screws during maintenance operations.

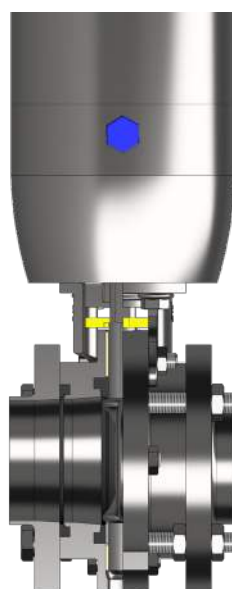

VVF- VALVOLA FARFALLA MANUALE

VVF è una valvola a farfalla manuale. È disponibile nella versione con maniglia in plastica a 5 posizioni, con maniglia in acciaio inox a 4 posizioni oppure con maniglia a regolazione millimetrica per un preciso controllo di passaggio dei fluidi.

VVF- MANUAL BUTTERFLY VALVE

VVF is a manual butterfly valve which cuts off and monitors fluids in the process flow by movements of opening and closing. Available in versions with a plastic 5-position handle, stainless steel 4-position handle or with a millimetric regulation handle for precision measuring of fluid passage.



Maniglia in plastica
Plastic handle



Maniglia in acciaio
Stainless steel handle



Maniglia in acciaio a regolazione millimetrica
Stainless steel handle with millimetric regulation

SENSORI PER VVF

L'applicazione di uno o due sensori consente la segnalazione della posizione di valvola aperta e di chiusa.

VVF PROXIMITIES

The installation of 1 or 2 inductive sensors advises on valve positioning during open and close phases.

VVF MANIGLIA PLASTICA 1-2 SENSORE			BUTTEFLY VALVE WITH 1-2 SENSORS
VVF MANIGLIA PLASTICA 1-2 SENSORE CILINDRICO			BUTTEFLY VALVE WITH 1-2 CILYNDRIC SENSORS
VVF MANIGLIA IN ACCIAIO CON 1 -2 SENSORE			BUTTEFLY VALVE WITH STAINLESS STEEL HANDLE WITH 1-2 SENSORS
VVF MANIGLIA IN ACCIAIO CON 1 -2 SENSORE CILINDRICO			BUTTEFLY VALVE WITH STAINLESS STEEL HANDLE WITH 1-2 CILYNDRIC SENSORS

MANIGLIA LUCCHETTABILE

Accessorio che consente il bloccaggio della valvola per evitare manomissioni.



LOCKABLE HANDLE

Accessory that allows valve locking to avoid tampering.

LIMITATORE DI CORSA

Accessorio che consente di limitare meccanicamente la corsa della valvola.



STROKE LIMITER

Adjustable device which allows the mechanical limitation of valve stroke.



ZVFM CON POSIZIONATORE

Applicando un posizionatore digitale ad una valvola a farfalla pneumatica si ha una valvola di regolazione che consente semplici controlli sul passaggio del fluido.

Il posizionatore digitale consente di controllare con precisione la posizione della valvola, convertendo un segnale analogico 4-20 mA nell'esatta posizione della farfalla. L'autocalibrazione consente una facile e rapida messa in servizio della valvola.

In condizioni di valvola ferma il consumo di aria è trascurabile.



VALVE WITH POSITIONER

By applying a digital positioner to a pneumatic butterfly valve, a valve is obtained that is simpler than a regulating valve one but which still allows simple controls on the passage of the fluid.

The digital positioner allows you to precisely control the valve position by converting an analog 4-20mA signal into the exact throttle position.

The self-calibration allows an easy and quick commissioning of the valve. In conditions with the valve stopped, the air consumption is negligible.



ESECUZIONI SPECIALI SU RICHIESTA

Ogni accessorio è disponibile su richiesta del cliente per tutti i diametri e tutte le configurazioni corpi valvola. È inoltre possibile la personalizzazione di attacchi, diametri oppure soluzioni non presenti a catalogo. Bardiani Valvole consiglia di consultare sempre l'ufficio tecnico in fase d'ordine per ulteriori informazioni e studi di fattibilità.

SPECIAL OPTIONS AND VARIATION ON REQUEST

On request all accessories are available for all sizes of valve and body configurations. Additionally special ports, diameters and other tailor-made solutions are available.

Bardiani Valvole can also provide technical support, advice and feasibility analysis for other requests.

SALDARE

WELD

DIN 11850-2

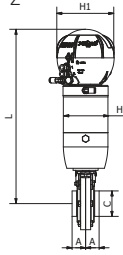

DN	A	B	B1	C	D	E	E1	H	H1	L
10	25	97	88	13x1.5	62	160	150	90	112	323
15	25	97	88	19x1.5	62	160	150	90	112	323
20	26	106	88	23x1.5	80	160	150	90	112	331
25	26	106	97	29x1.5	80	160	150	90	112	331
32	26	108	99	35x1.5	85	160	150	90	112	333
40	25	112	103	41x1.5	92	160	150	90	112	337
50	27	118	109	53x1.5	104	160	150	90	112	343
65	30	129	119	70x2	125	160	150	105	112	356
80	32	137	128	85x2	142	160	150	105	112	364
100	36	147	138	104x2	162	160	150	105	112	374
125	56	-	161	129x2	200	-	219	168	145	491
150	62	-	176	154x2	230	-	219	168	145	504

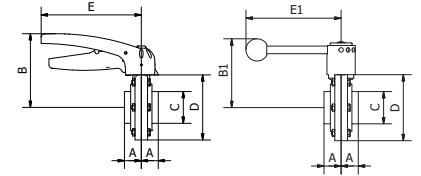

SALDARE

WELD

DIN

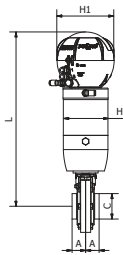

DN	A	B	B1	C	D	E	E1	H	H1	L
25	26	106	97	28x1.5	80	160	150	90	112	331
32	26	108	99	34x1.5	85	160	150	90	112	333
40	25	112	103	40x1.5	92	160	150	90	112	337
50	27	118	109	52x1.5	104	160	150	90	112	343

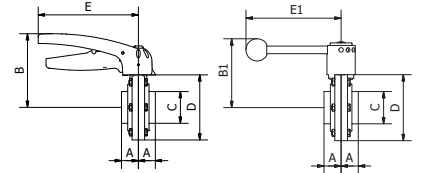

FEMMINA

MALE

DIN

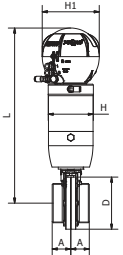

DN	A	B	B1	D	E	E1	H	H1	L
10	34	97	88	62	160	150	90	112	323
15	34	97	88	62	160	150	90	112	323
20	35	106	88	80	160	150	90	112	331
25	35	107	97	80	160	150	90	112	331
32	35	109	99	85	160	150	90	112	333
40	35	112	103	92	160	150	90	112	337
50	37	118	109	104	160	150	90	112	343
65	41	129	119	125	160	150	105	112	356
80	46	137	128	142	160	150	105	112	364
100	47	147	138	162	160	150	105	112	374
125	56	161	161	200	-	219	168	145	491
150	62	176	176	230	-	219	168	145	504

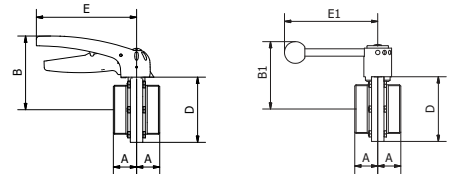

MASCHIO+GIRELLA

LINER+NUT

DIN

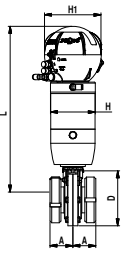

DN	A	B	B1	D	E	E1	H	H1	L
10	-	-	-	-	-	-	-	-	-
15	35	97	88	62	160	150	90	112	323
20	35	106	88	80	160	150	90	112	331
25	38	107	97	80	160	150	90	112	331
32	41	109	99	85	160	150	90	112	333
40	41	112	103	92	160	150	90	112	337
50	46	118	109	104	160	150	90	112	343
65	50	129	119	125	160	150	105	112	356
80	57	137	128	142	160	150	105	112	364
100	70	147	138	162	160	150	105	112	374
125	90	-	161	200	-	219	168	145	491
150	99	-	176	230	-	219	168	145	504

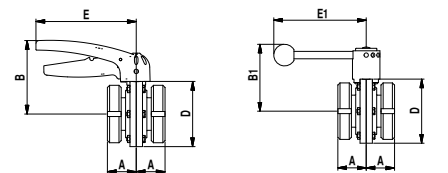

FEMMINA - SALDARE
MALE - WELD

DIN

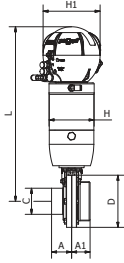

DN	A	A1	B	B1	C	D	E	E1	H	H1	L
10	25	34	97	88	13x1,5	62	160	150	90	112	323
15	25	34	97	88	19x1,5	62	160	150	90	112	323
20	26	35	106	88	23x1,5	80	160	150	90	112	331
25	26	35	107	97	29x1,5	80	160	150	90	112	331
32	26	35	109	99	35x1,5	85	160	150	90	112	333
40	25	35	112	103	41x1,5	92	160	150	90	112	337
50	27	37	118	109	53x1,5	104	160	150	90	112	343
65	30	41	129	119	70x2	125	160	150	105	112	356
80	32	46	137	128	85x2	142	160	150	105	112	364
100	36	47	147	138	104x2	162	160	150	105	112	374
125	56	56	-	161	129x2	200	-	219	168	145	491
150	62	62	-	176	154x2	230	-	219	168	145	504

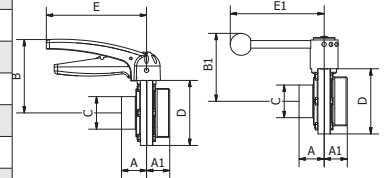

MASCHIO+GIRELLA -
FEMMINA
LINER+NUT - MALE

DIN

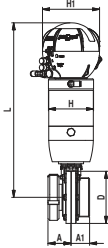

DN	A	A1	B	B1	D	E	E1	H	H1	L
10	-	-	-	88	-	-	150	-	-	-
15	35	34	97	88	62	160	150	90	112	323
20	38	35	106	88	80	160	150	90	112	331
25	38	35	107	97	80	160	150	90	112	331
32	41	36	109	99	85	160	150	90	112	333
40	41	35	112	103	92	160	150	90	112	337
50	46	37	118	109	104	160	150	90	112	343
65	50	41	129	119	125	160	150	105	112	356
80	57	46	137	128	142	160	150	105	112	364
100	70	47	147	138	162	160	150	105	112	374
125	90	56	-	161	200	-	219	168	145	491
150	99	62	-	176	230	-	219	168	145	504

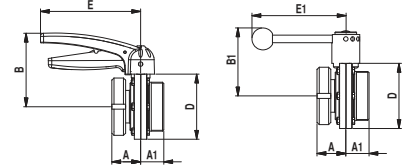

WAFER4

DIN 11850-2

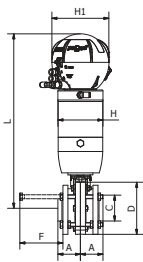

DN	A	B	B1	C	D	E	E1	F	H	H1	L
15	45	97	88	19x1,5	62	160	150	90	90	112	323
20	45	107	88	23x1,5	80	160	150	90	90	112	331
25	45	107	97	29x1,5	80	160	150	90	90	112	331
32	45	109	99	35x1,5	85	160	150	90	90	112	333
40	45	112	103	41x1,5	92	160	150	90	90	112	337
50	45	118	109	53x1,5	104	160	150	90	90	112	343
65	45	129	119	70x2	125	160	150	90	105	112	356
80	49	137	128	85x2	142	160	150	100	105	112	364
100	52	147	138	104x2	162	160	150	105	105	112	374
125	61	-	161	129x2	200	-	219	115	168	145	491
150	71	-	176	154x2	230	-	219	130	168	145	504

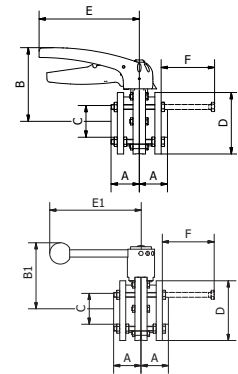

WAFER4

INCH

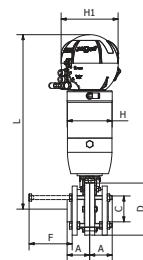

DN	A	B	B1	C	D	E	E1	F	H	H1	L
1"	45	107	97	25.4x1.5	80	160	150	90	90	112	331
1 1/2"	45	112	103	38.1x1.5	92	160	150	90	90	112	337
2"	45	118	109	50.8x1.5	104	160	150	90	90	112	343
2 1/2"	45	129	119	63.5x1.5	125	160	150	90	105	112	355
3"	49	137	128	76.1x2	142	160	150	105	105	112	359
4"	52	147	138	101.6x2	162	160	150	115	105	112	374

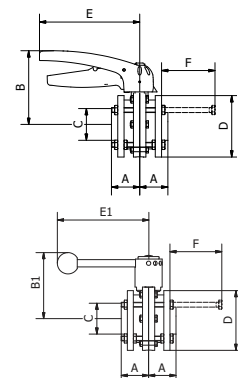

WAFER4

ASME-BPE

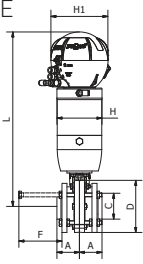

DN	A	B	B1	C	D	E	E1	F	H	H1	L
3/4"	45	107	88	19.05x1.65	80	160	150	90	90	112	331
1"	45	107	97	25.4x1.65	80	160	150	90	90	112	331
1 1/2"	45	112	103	38.1x1.65	92	160	150	90	90	112	337
2"	45	118	109	50.8x1.65	104	160	150	90	90	112	343
2 1/2"	45	129	119	63.5x1.65	125	160	150	90	105	112	355
3"	49	137	128	76.2x1.65	142	160	150	105	105	112	359
4"	52	147	138	101.6x2.11	162	160	150	115	105	112	374
6"	71	-	176	152.4x2.77	230	-	219	130	168	145	504

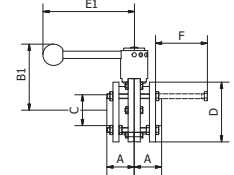
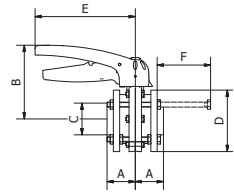

SALDARE

WELD

INCH

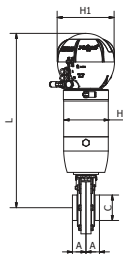

DN	A	B	B1	C	D	E	E1	H	H1	L
1"	26	107	97	25.4x1.5	80	160	150	90	112	331
1 1/2"	25	109	103	38.1x1.5	92	160	150	90	112	337
2"	27	112	109	50.8x1.5	104	160	150	90	112	343
2 1/2"	28	126	119	63.5x1.5	120	160	150	105	112	355
3"	30	131	128	76.1x2	130	160	150	105	112	359
4"	36	147	138	101.6x2	162	160	150	105	112	374
5"	56	-	161	127x2	200	220	150	168	145	491

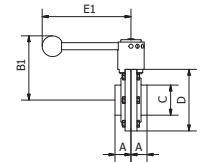
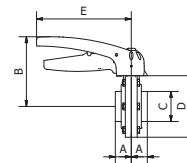

SALDARE

WELD

ASME-BPE

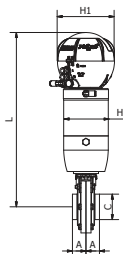

DN	A	B	B1	C	D	E	E1	H	H1	L
1/2"	25	97	88	12.7x1.65	62	160	150	90	112	323
3/4"	25	97	88	19.05x1.65	62	160	150	90	112	323
1"	26	107	97	25.4x1.65	80	160	150	90	112	331
1 1/2"	25	109	103	38.1x1.65	92	160	150	90	112	337
2"	27	112	109	50.8x1.65	104	160	150	90	112	343
2 1/2"	28	126	119	63.5x1.65	120	160	150	105	112	355
3"	30	131	128	76.2x1.65	130	160	150	105	112	359
4"	36	147	138	101.6x2.11	162	160	150	105	112	374
6"	62	-	161	152.4x2.77	230	220	219	168	145	504

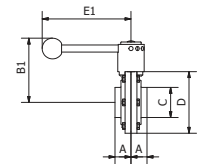
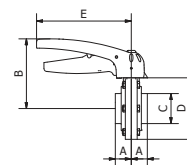

CLAMP

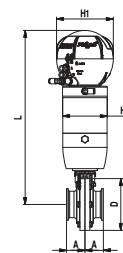

DN	A	B	B1	D	E	E1	H	H1	L
1"	35	107	97	80	160	150	90	112	331
1 1/2"	35	109	103	92	160	150	90	112	337
2"	37	112	109	104	160	150	90	112	343
2 1/2"	41	126	119	120	160	150	105	112	356
3"	43	131	128	130	160	150	105	112	364
4"	51.5	147	138	162	160	150	105	112	374
6"	48	-	161	230	-	219	167	145	504

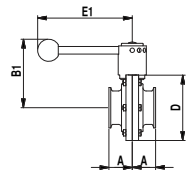
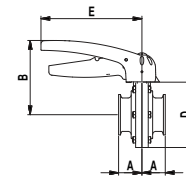

FEMMINA

MALE

SMS

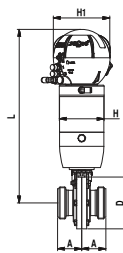

DN	A	B	B1	D	E	E1	H	H1	L
1"	35	107	97	80	160	150	90	112	331
1 1/2"	37	109	103	92	160	150	90	112	337
2"	39	112	109	104	160	150	90	112	343
2 1/2"	52	126	119	120	160	150	105	112	356
3"	54	131	128	130	160	150	105	112	364
4"	61	147	138	162	160	150	105	112	374

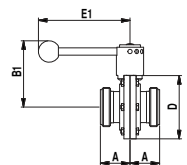
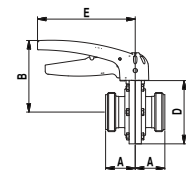

LEGENDA / KEY

-	Su richiesta / On demand
---	--------------------------

FEMMINA
MALE
IDF

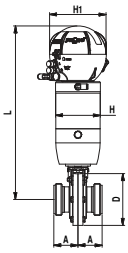

DN	A	B	B1	D	E	E1	H	H1	L
1"	47.5	107	97	80	160	150	90	112	331
1 1/2"	46.5	109	103	92	160	150	90	112	337
2"	48.5	112	109	104	160	150	90	112	343
2 1/2"	49.5	126	119	120	160	150	105	112	355
3"	51.5	131	128	130	160	150	105	112	359
4"	57.5	147	138	162	160	150	105	112	374

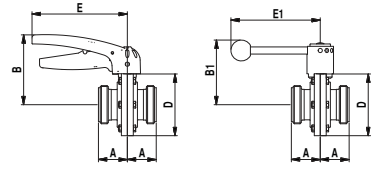

FEMMINA
MALE
BS (RJT)

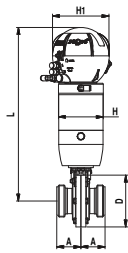

DN	A	B	B1	D	E	E1	H	H1	L
1"	47.5	107	97	80	160	150	90	112	331
1 1/2"	46.5	109	103	92	160	150	90	112	337
2"	48.5	112	109	104	160	150	90	112	343
2 1/2"	49.5	126	119	120	160	150	105	112	355
3"	51.5	131	128	130	160	150	105	112	359
4"	57.5	147	138	162	160	150	105	112	374

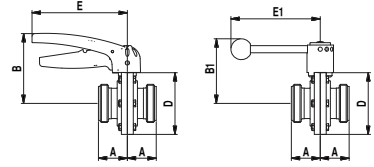

DIMENSIONI ATTUATORE PNEUMATICO MACH PER VALVOLA FARFALLA PNEUMATIC MACH ACTUATOR DIMENSIONS FOR BUTTERFLY VALVE

MACH 83-98

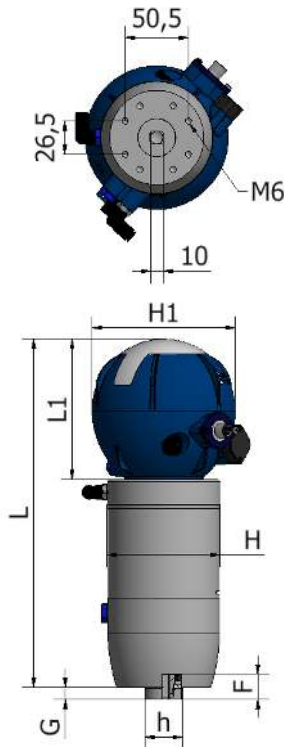

MACH 156

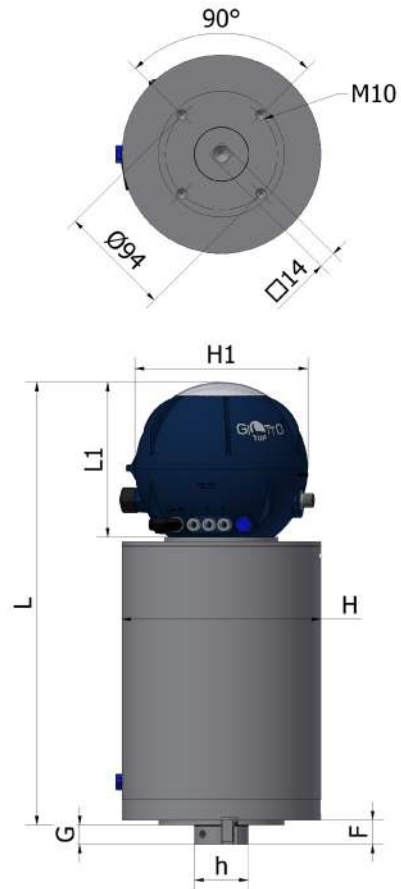

	F	G	H	H1	h	L	L1
83 SE - DE	20	10	90	112	30	275	109
98 SE - DE	20	10	105	112	30	275	109
156 SE - DE	20	16	168	145	45	370	128

LEGENDA / KEY	
SE	Semplice Effetto / Single acting
DE	Doppio Effetto / Double Acting
83 - 98 - 156	Diametro attuatore / Actuator diameter

