



FLUID COMPONENTS

FLUID MANAGEMENT Components



v.032

Tube Size Reference

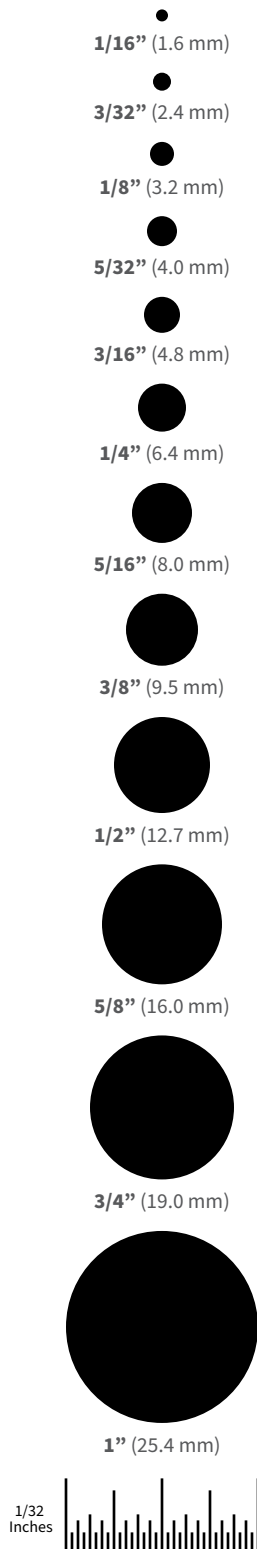

Barb Reference

Pg 120 Barb Series' Characteristics

Pg 120 Barb Dimensions

Pg 122 Barb Performance

Common Material Reference

- 001 (Various, see part description)
- 06 Orange Nylon
- 07 Yellow Nylon
- 0 Natural Nylon
- 1 White Nylon
- 2 Black Nylon
- 3 Red Nylon
- 4 Green Nylon
- 5 Blue Nylon
- 7 Glass Filled Natural Nylon
- 8 Gray Nylon
- 8B Gray Nylon
- 9 Clear Polycarbonate
- 10 Acetal
- 40 Polysulfone
- 50 Acrylic
- 81 Lace White ABS
- 91 White Polycarbonate
- 1006 Natural Acetal
- 1007 Black Acetal
- 6005 Animal-free Polypropylene
- 6006 White Polypropylene
- 6012 Black Polypropylene
- 8003 Natural ABS
- 8012 White ABS
- 9002 Rad. Stable Polycarbonate
- 9010 Rad. Stable Polycarbonate
- 9024 Polycarbonate
- B Buna-N O-ring
- CM006 Polyethylene
- CM018 Copolyester
- CM030 Dark Blue Nylon
- E PTEE/EPDM
- EP EPDM O-ring
- J2A Natural Kynar PVDF
- J2A2 Natural Kynar PVDF
- PX Platinum-cured Silicone
- U71 White Class VI Glass Filled Nylon
- U75 Blue Class VI Glass Filled Nylon
- VP1 Animal-free Polyethylene
- X2 Buna-N Rubber
- XO Stainless Steel

Resin Information

Pg 128 Chemical Resistance

Pg 129 Regulatory Status

Pg 130 Sterilization Stability

Pg 131 Typical Properties

INTRODUCTION	4	DIVERT™ STOPCOCKS	72
COMPONENTS & TECHNOLOGIES	6	Standard Pressure Stopcocks	73
LOCATION	6	High Pressure Stopcocks	73
CUSTOM ENGINEERED SOLUTIONS	8	BIOPROCESS FITTINGS	74
LUERS	10	Bag Ports	74
Male	11	BioProcessing Check Valves	77
Female	13	Opposing Barb Ports	78
Adapters and Couplers	15	Pharma+™ Tubing Retainers	79
Tees	15	BioClamp®	80
Elbows	15	BioValve®	81
Plugs and Caps	16	PharmaLok™ Clamps	82
Luer to Thread	17	PharmaLok™ Tube Clamps	85
Panel Mounts	18	Spaulding™ Aseptic Disconnects	86
Panel Mount Accessories	19	CYLINDRAFlow™ Manifolds	88
TUBE FITTINGS	20	Sanitary Fittings - Mini Flange	89
Straight Through	21	Sanitary Fittings - Maxi Flange	90
Straight Through Reducer	22	Sanitary Fittings - Caps	92
Elbow	24	Sanitary Fittings - TC Reducers	92
Elbow Reducer	25	Gaskets	93
Tee	25	Large Tube Fittings - Straight Through	95
Y	26	Large Tube Fittings - Straight Through Reducer	95
Multiport	29	Large Tube Fittings - Elbow	96
Press-In Plugs	30	Large Tube Fittings - Elbow Reducer	96
Ultrasonically Weldable Barbs	31	Large Tube Fittings - Tee	97
Panel Mounts	31	Large Tube Fittings - Tee Reducer	97
Panel Mount Accessories	31	Large Tube Fittings - Y	98
ISO 80369	32	Large Tube Fittings - Y Reducer	98
ISO 80369-3 (Enteral) Compliant Connectors	33	Large Tube Fittings - Multiport	99
ISO 80369-5 (Blood Pressure) Compliant Connectors	33	Large Tube Fittings - Multiport Reducer	99
ISO 80369-6 (Neuraxial) Compliant Connectors	34	Large Tube Fittings - Press-In Plugs	99
ISO 80369-7 (Intravascular) Compliant Connectors	34	BLOOD PRESSURE	100
TUBING RETAINERS	35	BPF Series	100
QUICK CONNECT COUPLINGS	36	1/4 Turn Connectors	100
10 Series - 1/16" Flow Size	36	Bayonet Male Cuff Connectors	101
20 Series - 1/8" Flow Size	38	Dinamap® Monitor Adapters	101
30 Series - 1/8" Flow Size	45	Dinamap® Cuff Connectors	101
33 Series - 1/8" Flow Size	45	THREADED	102
40 Series - 1/4" Flow Size	46	10-32 UNF, Special Tapered Thread	103
42 Series - 3/32" Flow Size	50	1/4-28 UNF	106
50 Series - 1/4" Flow Size	51	1/4-28 UNF Bottom Sealing	107
55 Series - 1/4" Flow Size	54	Metric M6x1	108
60 Series - 3/8" Flow Size	54	Metric M5x.8	108
65 Series - 1/2" Flow Size	58	1/16-27 NPT	109
100 Series - 1/16" Flow Size	59	1/8-27 NPT	110
MQC Series	60	BUILD-A-PART®	112
RQ Series	61	Junction Blocks	113
SBL Series	62	Accessories	114
XQ Series	63	Barbs	114
Filtration Connectors	64	Threads	115
Custom Solutions	65	TUBING	116
CHECK VALVES	66	Linear Low Density Polyethylene	116
Single Check Valves - Anti-Siphon	66	Thermoplastic Elastomer (TPE)	116
High Flow Check Valves	67	Platinum-Cured Silicone	117
Single Check Valves - One-Way	67	Pump Grade Platinum-Cured Silicone	117
Single Check Valves - Barbed	68	Polyurethane	117
Double Check Valves	69	Anti-Microbial Polyvinyl Chloride (PVC)	117
NEEDLEFREE SWABABLE VALVES	70	OTHER COMPONENTS	118
Vial Caps	70	Tapered Seal	118
Swabable Bag Valves	71	Clamps	119
Valved Male Luers	71	Injection Sites	119
Swabable Break-Off Valves	71	Spikes	119
Swabable "Y" Valves	71	TECHNICAL INFORMATION	120
Swabable Straight Valves	71	Barb Dimensions	120
Bondable Valves	71	Barb Performance	122
		Quick Connect Performance Ratings	123
		BPF Series Properties and Performance Data	127
		Panel Mount Instructions	127
		Resin Information	128
		Trademarks	131
		Index	132

Welcome to Nordson MEDICAL!

Thank you for your interest in our products. If you're a current customer, we appreciate your business and look forward to exceeding your expectations in the future. If you're seeing us for the first time, we welcome the opportunity to earn your trust.

Nordson MEDICAL is backed by the extensive resources of Nordson Corporation (Nasdaq: NDSN), the world leader in precision dispensing, fluid management and related technologies.

We are your global integrated solutions partner in the design, development, and manufacturing of complex medical devices and component technologies. We serve interventional, surgical, and specialized markets as the engine of innovations that save or enhance patients' lives.

We work with companies at any point in the product lifecycle to bring their innovative ideas to life. As a single-source partner, we enable our customers to save costs and speed time to market.

Our online store is the largest in the industry, giving customers fast access to thousands of components and technologies in stock and ready to ship, most within 24 hours.

Our three areas of focus provide customers with a complete solution:

Design & Development

Our 200+ technical team brings broad medical device expertise and a deep understanding of clinical applications. Services include:

- Concept generation
- Product design & engineering
- Rapid prototyping
- Project management
- New product introduction
- Testing & validation
- Quality & regulatory services

Components & Technologies

Our extensive portfolio of stock and custom components gives customers one-stop access to the critical building blocks for their complex, innovative medical devices.

- Fluid management components
- Catheters & cannulae
- Medical balloons
- Medical tubing
- Biomaterial delivery devices
- Nitinol components

Finished Device Solutions

We can leverage our in-house component and technology expertise to design, develop, and manufacture finished medical devices and subassemblies. This vertical integration helps teams reduce costs, mitigate risk, streamline supply chain, and ensure consistent quality. Our services include:

- Full-service manufacturing
- Finished devices & subassemblies
- Global manufacturing sites
- Dedicated transfer team
- Supply chain management
- Robust continuous improvement

What We Do

Our fluid management portfolio includes thousands of components designed specifically for flexible tubing in different style and material combinations. The Value Plastics product line includes luer fittings, check valves, bioprocessing fittings, tube fittings, threaded fittings, and blood pressure monitoring components. Our LinkTech line of quick connect couplings allows you to quickly and easily connect or disconnect fluid transfer lines and is available in a wide range of flow sizes. We also offer custom component manufacturing, tubing, and select medical OEM components. Our application expertise extends to bioprocessing, blood pressure, cardiovascular, ophthalmic, and more. Our products find global application in demanding healthcare OEM, research and specialty industrial applications.

Our Quality Commitment to You

At Nordson MEDICAL, quality is designed in from the outset; it's not an add-on at the end of the process. Our Quality Management System is designed as a system of interrelated processes meeting the requirements of ISO 13485. We welcome our customers to conduct an on-site supplier audit with the knowledge that our systems have satisfied the most demanding requirements of medical device manufacturers worldwide. We are dedicated to exceeding your expectations.

Clean Room Manufacturing

Most Nordson MEDICAL products are manufactured and packaged in an environment that meets the requirements of ISO 14644-1 Class 8 (Class 100,000) standards. We utilize both manual and automated assembly processes tailored to manufacture the highest quality components.

Assembly and Finishing Capabilities

Nordson MEDICAL's quality products are sophisticated and reliable. We have a solid reputation in today's medical device and biotech markets with pressure and leak testing. We also offer manual, semi-automatic, and fully automatic finished good assembly.

Design, Engineering and R&D

Nordson MEDICAL's staff of product development professionals uses the most modern equipment to design the best products available anywhere. Whether your need is for new products or custom solutions, our focus on healthcare OEMs means we understand your needs and don't need to be coached to your industry requirements. Designs incorporating human factors, finite element analysis, DFMA, rapid prototyping and concurrent engineering are just some of the tools used to bring you the components you require, when you want them.

Manufacturing Consistency

Nordson MEDICAL is equipped with multiple injection molding machines including plastic injection molding and over molding including 2-shot and insert molding. Our all-electric injection molding presses are chosen for shot-to-shot consistency and outfitted with the most up-to-date process monitoring software available. Each operator is responsible for product quality at the press and has every tool at their disposal. All molding, secondary operations and packaging takes place in a controlled environment to assure component readiness for your production floor.

Rapid Prototyping

Nordson MEDICAL's engineering department is a leader in the industry. Using rapid prototyping and an in-house, high performance 3D printer, we can utilize multiple resins to provide certain material properties to components. We can execute highly representative prototypes and build a mold in two days, allowing us to deliver solutions with testable parts in a short time.

We use a system to verify potential product performance to expedite quality product design and development. The use of several tooling technologies allows us to incorporate innovative materials and processes to provide plastic components in a fraction of the time it may take to utilize metals.

We also execute detailed processes for evaluating application requirements to ensure the design focuses on ease of use, cost efficiency, design manufacturability, and top notch performance.

Regulatory Management

Nordson MEDICAL strives to provide our customers with the most up-to-date technical information, directly from the resin manufacturer, on the resins we use. We maintain a comprehensive list of all material and regulatory information, enabling you to select the most appropriate products for your particular application. Information we provide includes:

- Regulatory data
- Material data
- MSDS
- Typical resin properties
- Sterilization stability information
- Chemical resistance information

Visit www.nordsonmedical.com for technical information.

Customer Satisfaction

As with all of our medical parts, each bag comes with a product certification and traceable lot number. Our parts are manufactured and bagged in a clean room environment to accelerate your own usage.

At Nordson MEDICAL, we are dedicated to exceeding your expectations. As such, it is important to us that when you place an order you know exactly what to expect, when to expect it and that we will do everything we can to ensure that you receive components made to the required specifications.

Nordson MEDICAL implements and regulates an internal customer support system. Our goal is to provide you exceptional service and quality solutions. We track all support issues in order to meet ISO requirements, enhance customer satisfaction, and to continuously improve our initiatives.

When a support issue concerns one of our products, we begin an immediate investigation of our available stock and quarantine any suspected parts. We then complete all required formal corrective actions and inform the customer when the issue is resolved.

To contact customer service, please call us at (888) 404-5837 or (970) 267-5200.

Contact Us

Visit us at www.nordsonmedical.com for all your low pressure fluid management needs.

Fluid Management Components

With the largest selection in the industry, we offer cost-effective solutions that connect fluid management systems. Our components join flexible tubing assemblies, allowing you to easily regulate the flow of valuable media. Process management components, like quick connect fittings, luers, and tube-to-tube fittings, effortlessly and securely connect different elements of fluid administration devices. We also offer devices like stopcocks and check valves that control the transfer of fluids by regulating directional flow.

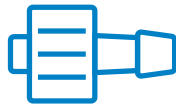

Catheters and Cannulae

Nordson MEDICAL can partner with you in all phases of catheter development, from design and development through manufacturing and assembly. In-house capabilities include custom balloon extrusions, balloon blowing, bonding, welding, and folding, coating and masking, printing, and more. Our expertise in engineered shafts includes braid- and coil-reinforced shafts. We can also utilize polymer solution casting technologies to build multiple performance characteristics and varying wall thicknesses and diameters into a single-piece construction, while maintaining tight tolerances.



Medical Balloons

We have the widest selection of medical balloons in the industry and can create any geometry with any material and virtually no limits on design. We offer the most complex medical balloons with the tightest tolerances, highest burst pressures, thinnest walls, and multiple unique design options, including coatings, textured surfaces, braided, and multilumen balloons.

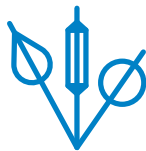

Medical Tubing

From simple medical tubing to complex, tight-tolerance extruded tubing in a wide range of materials, we can meet your needs. We're known for producing the world's thinnest, smallest, and strongest heat shrink tubing, and our tubing line has expanded to include specialized items like polyimide tubing, PTFE liners, ram-extruded PTFE tubing, and a full range of single-lumen, multilumen, and multilayer extruded tubing.

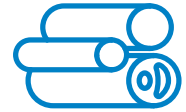

Biomaterial Delivery Devices

Nordson MEDICAL provides proven solutions for accurate and precise delivery of tissue sealants, hemostatics, adhesion barriers, and other autologous or synthetic biomaterials for surgical applications. We develop biomaterial delivery systems that accurately deliver a single biomaterial—or precisely mix and deliver a dual-component therapy—to the surgical site. Our OsteoXpress™ and OsteoPrecision™ Graft Delivery Devices deliver allograft, autograft, or synthetic bone graft materials to an orthopedic surgical site, and we provide stock, custom, and private label products to a wide range of customers.

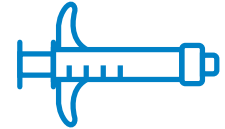

Nitinol Components

We are experts in complex manual nitinol wire braiding and forming and can achieve unique and complex geometries not possible by other methods. Symmetric and asymmetric structures are possible with spiral, wavy, or straight tip attachment options.



FLUID MANAGEMENT LOCATIONS

UNITED STATES:

Loveland, CO

805 West 71st Street
 Loveland, CO 80538, USA
 Phone: 970.267.5200
 Toll Free: 888.404.5837
 Orders@nordsonmedical.com



CUSTOM

ENGINEERED SOLUTIONS



“It would have taken me two to three times as long and two to three times as much money without Nordson MEDICAL. This is who you want to work with. They have become part of our team.”



What happens when “off-the-shelf” just doesn’t work?

The Nordson MEDICAL custom solutions team builds a new shelf!

Unable to find what you’re looking for? Nordson MEDICAL has you covered with an array of product development and manufacturing capabilities to develop a product that perfectly meets your needs. Whether it’s a slight modification of one of our extensive catalog components, a design that you need manufactured, or something completely unique that requires full product development, Nordson MEDICAL has the experience and proficiency to support your project from concept through full-scale manufacturing.

Nordson MEDICAL has a wide range of capabilities that are utilized throughout the product development process to ensure the finished developed product is successful for years to come. Many of the custom engineered products developed by our Fluid Management team have been on the market for decades and are continuing to thrive.

Specialties:

- Custom Components
- Custom Devices
- Custom Quick Connects
- Custom Check Valves
- Custom Stopcocks
- And more

To get started today contact our sales team:
Toll Free - +1 (888) 404-5837
Email - Orders@nordsonmedical.com



Areas of Expertise for Long-Term Product Success

Innovation:

Why settle for good enough when you can have great? Beyond coming up with a solution that simply “does the job,” Nordson MEDICAL’s team of product development engineers will raise the bar and creatively drive the solution toward market differentiation. Our unique combination of innovative product development paired with robust and reliable manufacturing experience will ensure a good foundation when moving to full production scale-up later down the road.

- Concept Development
- Technology Development
- Industrial Design
- Engineering Analysis & Simulation

Product Development:

Great ideas paired with industry-leading innovation are the source that, with proper planning and attention, have the ability to become a ground-breaking product. Nordson MEDICAL engineers have the experience and tools in product innovation to make ideas a reality. The combination of engineering analysis, high-precision on-site mold making, and lights-out highly automated manufacturing ensures products developed by Nordson MEDICAL not only meet the most demanding of applications but are scalable when released to manufacturing.

- DFM, DFA, DFX
- Prototyping
- Bridge Manufacturing
- Full-Scale Production
- Secondary Services
- Engineering & QA Services

Full-Scale Manufacturing:

Taking a great product design and scaling it to millions of components per year in a highly regulated industry is no easy feat. With decades of high-volume precision medical manufacturing experience in a highly automated clean room environment, Nordson MEDICAL is your trusted source to bring your product to fruition.

- High-Precision Molding
- Clean Room Manufacturing
- Full Lot & Process Traceability
- Assembly & Automation Engineering
- Medical Device Manufacturing

Product Launch & Post-Market Support:

With Nordson MEDICAL, you can be assured we will be there along the way to keep things on track and to work with you to tackle any challenges that arise. With full quality and engineering support, along with a full-capability tool shop on site, Nordson MEDICAL offers full postproduction support to meet your needs through the entire product life cycle.

- Quality Support
- Engineering Support
- Regulatory Support
- Lifetime Tool Maintenance & Repair Included

LUER

FITTINGS



Male Luers
PG-11



Female Luers
PG-13



Adapters
PG-15



Couplers
PG-15



Tees
PG-15



Elbows
PG-15



Plugs and Caps
PG-16



Luer to Thread
PG-17



Panel Mounts & Accessories
PG-19



Our Luer Tapers

Nordson MEDICAL's luer tapers are made to the ISO 594-1 and ISO 594-2 standards, and may be connected to other luers meeting these ISO standards. Please test your application to verify the performance of the interconnection.

Nordson MEDICAL's luer fittings come in over 100 configurations and several materials for the device designer, joining tubing from 1/16" (1.6 mm) ID to 1/4" (6.4 mm) ID.

Features & Benefits:

Published ISO Design Standard

- Well understood worldwide
- Often assures interconnections without need to retrofit

Rotating Lock Permits Tube Positioning Prior To Tightening

- Minimizes twisting and kinking of tubing

Tapered Cone Seal

- Reliable
- Inexpensive
- Uncomplicated

Available In Many Materials

- Facilitates optimal material selection for your application

Inexpensive

- Facilitates single-use

Easy To Understand

- Ease of use in field

Many Configuration Options

- Adaptable to wide range of applications

Security Options (Fixed Lock, Rotating Lock, No Lock)

- Tailorable to your specific application

Custom Assembly

We produce standard components to fit your current assemblies and devices, but we also provide custom solutions by applying a variety of assembly options, such as joining fittings, connectors, filters, and other components to tubing. From systems using a single fitting to complex configurations utilizing various components, we can design complete assemblies to your requirements.

MALE LUER: Integral Lock Ring

MTLL210 (-1 -3 -4 -5 -6005 -9 -9002 -J2A)

Male Luer Integral Lock Ring to 200 Series Barb, 1/16" (1.6 mm) ID Tubing



MTLL410 (-9)

Male Luer Integral Lock Ring to 400 Series Barb, 1/16" (1.6 mm) ID Tubing



MTLL004 (-1 -2 -3 -4 -6005)

Male Luer Integral Lock Ring to 500 Series Barb, 1/16" (1.6 mm) ID Tubing



MTLL220 (-1 -2 -4 -5 -6005 -9 -9002 -J2A)

Male Luer Integral Lock Ring to 200 Series Barb, 3/32" (2.4 mm) ID Tubing



MTLL420 (-1 -6005)

Male Luer Integral Lock Ring to 400 Series Barb, 3/32" (2.4 mm) ID Tubing



MTLL007 (-1 -6005 -9)

Male Luer Integral Lock Ring to 500 Series Barb, 3/32" (2.4 mm) ID Tubing



MTLL230 (-1 -2 -3 -6005 -9 -9002 -J2A -CM550)

Male Luer Integral Lock Ring to 200 Series Barb, 1/8" (3.2 mm) ID Tubing



MTLL430 (-3 -6005 -9002 -J2A)

Male Luer Integral Lock Ring to 400 Series Barb, 1/8" (3.2 mm) ID Tubing



MTLL013 (-1 -2 -3 -6005 -9 -9002)

Male Luer Integral Lock Ring to 500 Series Barb, 1/8" (3.2 mm) ID Tubing



MTLL240 (-1 -6005 -06 -07 -9 -J2A)

Male Luer Integral Lock Ring to 200 Series Barb, 5/32" (4.0 mm) ID Tubing



MTLL025 (-1 -2 -4 -5 -6005 -06 -07 -9)

Male Luer Integral Lock Ring to 500 Series Barb, 5/32" (4.0 mm) ID Tubing



MTLL445 (-6005 -9002)

Male Luer Integral Lock Ring to 400 Series Barb, .170" (4.3 mm) ID Tubing



MTLL250 (-1 -4 -06 -6005 -07 -8003 -9)

Male Luer Integral Lock Ring to 200 Series Barb, 3/16" (4.8 mm) ID Tubing



MTLL450 (-9 -9002 -J2A)

Male Luer Integral Lock Ring to 400 Series Barb, 3/16" (4.8 mm) ID Tubing



MTLL035 (-1 -06 -6005 -07 -9)

Male Luer Integral Lock Ring to 500 Series Barb, 3/16" (4.8 mm) ID Tubing



MTLL360 (-1 -6005 -9 -9002 -J2A)

Male Luer Integral Lock Ring to 300 Series Barb, 1/4" (6.4 mm) ID Tubing



MTLL055 (-1 -3 -4 -06 -6005 -9 -9002)

Male Luer Integral Lock Ring to 500 Series Barb, 1/4" (6.4 mm) ID Tubing



Part Drawings Online!

Nordson MEDICAL provides dimensional drawings available for download for all of its fittings.

www.nordsonmedical.com

MALE LUER: Slip, or for use with Lock Ring

FSLLR (-1 -2 -3 -4 -5 -6005 -07 -9 -9002)

Finger Snap Luer Lock Ring



MLRL004 (-1 -6005)

Male Luer to 500 Series Barb, 1/16" (1.6 mm) ID Tubing (May be used with separate rotating lock ring; FSLLR)



MLRL007 (-1 -6005 -6012)

Male Luer to 500 Series Barb, 3/32" (2.4 mm) ID Tubing (May be used with separate rotating lock ring; FSLLR)



MLSL007 (-9)

Male Luer to 500 Series Barb, 3/32" (2.4 mm) ID Tubing (May be used with separate stationary lock ring; FSLLR)



MLRL013 (-1 -6005 -9)

Male Luer to 500 Series Barb, 1/8" (3.2 mm) ID Tubing (May be used with separate rotating lock ring; FSLLR)



MLSL013 (-6005)

Male Luer to 500 Series Barb, 1/8" (3.2 mm) ID Tubing (May be used with separate stationary lock ring; FSLLR)



MLRL025 (-1 -6005 -9)

Male Luer to 500 Series Barb, 5/32" (4.0 mm) ID Tubing (May be used with separate rotating lock ring; FSLLR)



MLRL035 (-1 -6005 -9)

Male Luer to 500 Series Barb, 3/16" (4.8 mm) ID Tubing (May be used with separate rotating lock ring; FSLLR)



MLRL055 (-1 -9)

Male Luer to 500 Series Barb, 1/4" (6.4 mm) ID Tubing (May be used with separate rotating lock ring; FSLLR)



Need Samples for Evaluation?

You can call to request most of our standard product in quantities of 5, or less, for free application evaluation.

+1 (970) 267-5200 Toll Free: (888) 404-5837

It's a Lock with Nordson MEDICAL!

Our MLRL and MLSL Series of fittings can be used both as a slip luer or as a locking luer with the addition of our FSLLR luer lock ring, which allows color coding without flow path contact. Our MLSL/FSLLR combination results in a stationary lock ring. Use a combination of MLRL and FSLLR to create a color coded rotating lock ring.



MALE LUER:
Slip

MTLS210 (-1 -6005)

Male Luer Slip to 200 Series Barb, 1/16" (1.6 mm) ID Tubing



MSL004 (-1 -9 -9002)

Male Luer Slip to 500 Series Barb, 1/16" (1.6 mm) ID Tubing



MTLS220 (-1 -5 -6005 -6012 -9)

Male Luer Slip to 200 Series Barb, 3/32" (2.4 mm) ID Tubing

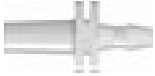

MSL007 (-9)

Male Luer Slip to 500 Series Barb, 3/32" (2.4 mm) ID Tubing

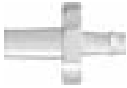

MTLS230 (-1 -3 -5 -6005 -9002 -J2A)

Male Luer Slip to 200 Series Barb, 1/8" (3.2 mm) ID Tubing



MSL013 (-9)

Male Luer Slip to 500 Series Barb, 1/8" (3.2 mm) ID Tubing

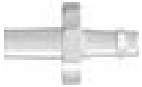

MTLS240 (-1 -81 -J2A)

Male Luer Slip to 200 Series Barb, 5/32" (4.0 mm) ID Tubing



MSL035 (-9002)

Male Luer Slip to 500 Series Barb, 3/16" (4.8 mm) ID Tubing



FEMALE LUER:
Thread Style

FTLL210 (-1 -3 -5 -6005 -9 -9002 -J2A)

Female Luer Thread Style to 200 Series Barb, 1/16" (1.6 mm) ID Tubing



FTLL410 (-1 -6005)

Female Luer Thread Style to 400 Series Barb, 1/16" (1.6 mm) ID Tubing



FTLL004 (-1 -6005 -9)

Female Luer Thread Style to 500 Series Barb, 1/16" (1.6 mm) ID Tubing



FTLL220 (-1 -3 -5 -6005 -9 -J2A)

Female Luer Thread Style to 200 Series Barb, 3/32" (2.4 mm) ID Tubing



FTLL420 (-1 -9 -J2A)

Female Luer Thread Style to 400 Series Barb, 3/32" (2.4 mm) ID Tubing



FTLL007 (-2 -4 -06 -6005 -9)

Female Luer Thread Style to 500 Series Barb, 3/32" (2.4 mm) ID Tubing



FTLL230 (-1 -2 -3 -6005 -9 -9002 -J2A -CM550)

Female Luer Thread Style to 200 Series Barb, 1/8" (3.2 mm) ID Tubing

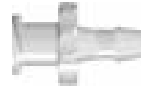

FTLL430 (-6005 -9002 -J2A)

Female Luer Thread Style to 400 Series Barb, 1/8" (3.2 mm) ID Tubing



FTLL013 (-1 -2 -3 -4 -5 -6005 -9002)

Female Luer Thread Style to 500 Series Barb, 1/8" (3.2 mm) ID Tubing



**FEMALE LUER:
Thread Style****FTLL240 (-1 -3 -5 -6005 -9 -9002)**

Female Luer Thread Style to 200 Series Barb, 5/32" (4.0 mm) ID Tubing

**FTLL025 (-1 -2 -4 -6005 -07 -9)**

Female Luer Thread Style to 500 Series Barb, 5/32" (4.0 mm) ID Tubing

**FTLL445 (-6005 -J2A)**

Female Luer Thread Style to 400 Series Barb, .170" (4.3 mm) ID Tubing

**FTLL250 (-1 -3 -6005 -9 -J2A)**

Female Luer Thread Style to 200 Series Barb, 3/16" (4.8 mm) ID Tubing

**FTLL450 (-6005 -9)**

Female Luer Thread Style to 400 Series Barb, 3/16" (4.8 mm) ID Tubing

**FTLL035 (-1 -06 -6005 -9)**

Female Luer Thread Style to 500 Series Barb, 3/16" (4.8 mm) ID Tubing

**FTLL360 (-1 -5 -6005 -9 -9002 -J2A)**

Female Luer Thread Style to 300 Series Barb, 1/4" (6.4 mm) ID Tubing

**FTLL055 (-1 -3 -4 -6005 -07 -9 -9002)**

Female Luer Thread Style to 500 Series Barb, 1/4" (6.4 mm) ID Tubing

**FEMALE LUER:
Smooth Bore Thread Style****FTLLSB004 (-6005)**

Female Luer Thread Style Smooth Bore to 500 Series Barb, 1/16" (1.6 mm) ID Tubing

**FTLLSB007 (-4)**

Female Luer Thread Style Smooth Bore to 500 Series Barb, 3/32" (2.4 mm) ID Tubing

**FTLLSB013 (-6005 -9)**

Female Luer Thread Style Smooth Bore to 500 Series Barb, 1/8" (3.2 mm) ID Tubing

**Why Choose a Smooth Bore?**

Our Smooth Bore Luers have a smooth inner transition providing for easy insertion of guide wires, probes and other devices.

**FEMALE LUER:
Lug Style****FTL10 (-1 -6005 -9)**

Female Luer Lug Style to Classic Series Barb, 1/16" (1.6 mm) ID Tubing

**FTL210 (-1 -6005 -9)**

Female Luer Lug Style to 200 Series Barb, 1/16" (1.6 mm) ID Tubing

**FTL20 (-1 -07 -81)**

Female Luer Lug Style to Classic Series Barb, 3/32" (2.4 mm) ID Tubing

**FTL220 (-1 -3 -5 -6005 -J2A)**

Female Luer Lug Style to 200 Series Barb, 3/32" (2.4 mm) ID Tubing

**FTL30 (-6005 -9)**

Female Luer Lug Style to Classic Series Barb, 1/8" (3.2 mm) ID Tubing



**FEMALE LUER:
Lug Style****FTL230 (-1 -6005 -9)**

Female Luer Lug Style to 200 Series Barb, 1/8" (3.2 mm) ID Tubing

**FTL240 (-1)**

Female Luer Lug Style to 200 Series Barb, 5/32" (4.0 mm) ID Tubing

**LUER:
Adapters, Couplers, and Lock Rings****FSLLR (-1 -2 -3 -4 -5 -06 -6005 -6012 -07 -9 -9002)**

Finger Snap Luer Lock Ring

**MLRLC (-1 -6005 -9)**

Male Luer Coupler (May be used with separate rotating lock rings; FSLLR)

**MTLCS (-1 -6005 -9)**

Male Luer Slip Coupler

**FTLLC (-1 -6005 -9 -9002 -J2A)**

Female Luer Thread Style Coupler

**FTLC (-1 -6005 -9002)**

Female Luer Lug Style Coupler

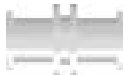
**LC34 (-1 -6005 -9)**

Male Luer Integral Lock Ring to Female Luer Thread Style Coupler

**LC78 (-6005 -9)**Male Luer to Female Luer Thread Style Coupler
(May be used with separate rotating lock ring; FSLLR)**LUER:
Adapters, Couplers, and Lock Rings****LT878 (-1 -6005)**Female Luer Thread Style (2) to Male Luer Tee
(May be used with separate rotating lock ring; FSLLR)**LT787 (-1 -6005 -8012)**Male Luer (2) to Female Luer Thread Style Tee
(May be used with separate rotating lock ring; FSLLR)**FTLT (-1 -6005 -9)**

Female Luer Lug Style Tee

**FTLLE (-6005 -9)**

Female Luer Thread Style Elbow

**FTLE (-6005 -9)**

Female Luer Lug Style Elbow

**LE87 (-1 -6005 -8003 -9 -9002)**Male Luer to Female Luer Thread Style Elbow
(May be used with separate rotating lock ring; FSLLR)**LE7220 (-1 -2)**Male Luer to 200 Series Barb Elbow, 3/32" (2.4 mm) ID Tubing
(May be used with separate rotating lock ring; FSLLR)**LE7230 (-1 -6005 -9 -9010)**Male Luer to 200 Series Barb Elbow 1/8" (3.2 mm) ID Tubing
(May be used with separate rotating lock ring; FSLLR)

LUER: Plugs and Caps

MTLLP (-1 -2 -6005 -9 -J2A)

Male Luer Integral Lock Ring Plug, Closed at Luer Tip



MTLLPV-6005

Male Luer Integral Lock Ring Plug, Closed at Grip, 80369-7 Compliant, Clear Polycarbonate



LP4 (-1 -3 -6005 -9 -9002 -J2A)

Male Luer Integral Lock Ring Plug, Closed at Grip

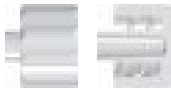

VLP4 (-1 -3 -6005 -81)

Male Luer Integral Lock Ring Vented Plug, Closed at Grip



MLRLP (-6005)

Male Luer Plug (May be used with separate rotating lock ring; FSLLR)



MLSLP (-9)

Male Luer Plug (May be used with separate stationary lock ring; FSLLR)



MTLP (-1 -6005)

Male Luer Plug, Closed at Tether Loop
(May be used with separate stationary lock ring; MLLR)

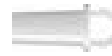

MTLSP (-1 -6005 -81)

Male Luer Slip Plug, Closed at Grip

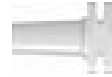

FTLP (-6005)

Female Luer Lug Style Cap with Tether Loop



FTLLP (-1 -2 -3 -5 -6005 -6012 -07 -81 -9 -9002 -J2A)

Female Luer Thread Style Cap



LP34 (-1 -3 -6005 -9 -9002)

Male Luer Integral Lock Ring to Female Luer Thread Style Plug



Need Samples for Evaluation?

You can call to request most of our standard product in quantities of 5, or less, for free application evaluation.

+1 (970) 267-5200 Toll Free: (888) 404-5837

Need it Fast?

You can order our parts online now with no order \$ minimums, 24 hours a day, 7 days a week!

www.nordsonmedical.com

LUER TO THREAD:

Male

ABSML-6005 UNDER (-1 -6012)

Male Luer with Rotating Lock Ring and 5/16" Hex to 1/4-28 UNF Bottom Sealing Thread

**18MTLL (-1 -2 -6005)**

Male Luer Integral Lock Ring with 7/16" Hex to 1/8-27 NPT Thread

**XMTLL (-1 -9)**

Male Luer Integral Lock Ring to 10-32 Special Tapered Thread

**14MTLL (-1 -6005 -6012)**

Male Luer Integral Lock Ring with 9/16" Hex to 1/4-18 NPT Thread

**SMTLL (-1 -6005 -J2A)**

Male Luer Integral Lock Ring to 1/4-28 UNF Thread

**BSMLRL (-6005)**

Male Luer with 5/16" Hex to 1/4-28 Bottom-Sealing Thread (May be used with separate rotating lock ring; FSLLR)

**Need More Details?**

Part drawings, minimum order quantities, and CAD requests can be found online. Visit www.nordsonmedical.com or contact Sales at Orders@nordsonmedical.com.

Looking for Something Different?

Most of our best product ideas have come from you, our customers. While we pride ourselves on our extensive product offering, we recognize that your needs are ever-changing and that our products, too, must adapt to your needs.

If there's a new product you think Nordson MEDICAL should make, please send us an Email at Orders@nordsonmedical.com describing your product concept in as much detail as you desire. We will contact you with any questions, and who knows - the next catalog edition could include products YOU told us to build.

See page 8-9 for more information on custom engineered solutions!



LUER TO THREAD:
Female**XFTLL (-1 -6005)**

Female Luer Thread Style with 1/4" Hex to 10-32 Special Tapered Thread

**KFTLL (-1 -6005 -9)**

Female Luer Thread Style with 1/4" Hex to 10-32 UNF Thread

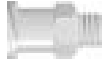
**SFTLL (-1 -4 -06 -6005 -9)**

Female Luer Thread Style with 5/16" Hex to 1/4-28 UNF Thread

**BSFTLL (-1 -6005)**

Female Luer Thread Style with 5/16" Hex to 1/4-28 UNF Bottom Sealing Thread

**XFTL (-6005 -9)**

Female Luer Lug Style with 1/4" Hex to 10-32 Special Tapered Thread

**SFTL (-1 -9)**

Female Luer Lug Style with 5/16" Hex to 1/4-28 UNF Thread

**18FTLL (-1 -6005 -J2A)**

Female Luer Thread Style with 7/16" Hex to 1/8-27 NPT Thread

**18LFTLL (-1 -6005 -J2A)**

Female Luer Thread Style Elbow with 7/16" Hex to 1/8-27 NPT Thread

**PANEL MOUNTS:**
Female Thread Style**FTLLB210 (-1 -6005 -9 -J2A)**

Female Luer Thread Style Panel Mount 1/4-28 UNF to 200 Series Barb, 1/16" (1.6 mm) ID Tubing

**FTLLB220 (-1 -2 -6005 -9 -J2A)**

Female Luer Thread Style Panel Mount 1/4-28 UNF to 200 Series Barb, 3/32" (2.4 mm) ID Tubing

**FTLLB230 (-1 -2 -6005 -J2A)**

Female Luer Thread Style Panel Mount 1/4-28 UNF to 200 Series Barb, 1/8" (3.2 mm) ID Tubing

**FTLLBMLRL (-6005)**

Female Luer Thread Style Panel Mount 1/4-28 UNF to Male Luer (May be used with separate rotating lock ring; FSLLR)

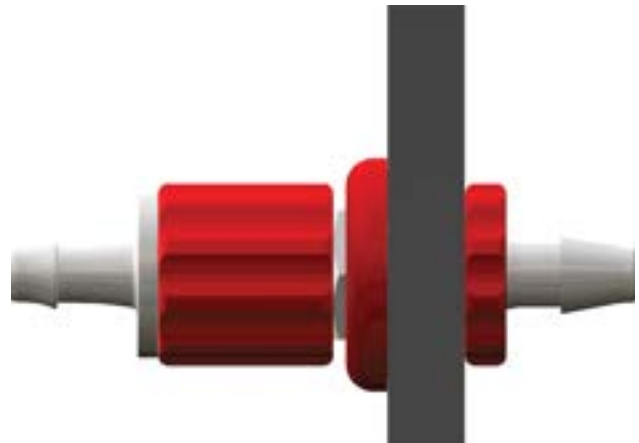
**Fully Assembled Panel-Mounted Luer****Need More Details?**Additional threaded solutions are shown on **PG-102-111**. Check out all of our threaded style parts at www.nordsonmedical.com or contact Sales at Orders@nordsonmedical.com.**Did You Know?**Nordson MEDICAL has an interactive PDF available online at www.nordsonmedical.com. Access part drawings, reference charts, data sheets, and more from just one location!

PANEL MOUNTS:
Female Lug Style and Male Luer

FTLB210 (-1 -6005)

Female Luer Lug Style Panel Mount 1/4-28 UNF to 200 Series Barb, 1/16" (1.6 mm) ID Tubing



FTLB220 (-1 -9)

Female Luer Lug Style Panel Mount 1/4-28 UNF to 200 Series Barb, 3/32" (2.4 mm) ID Tubing



FTLB230 (-1)

Female Luer Lug Style Panel Mount 1/4-28 UNF to 200 Series Barb, 1/8" (3.2 mm) ID Tubing



MLRLB210 (-6005)

Male Luer Panel Mount 10-32 UNF to 200 Series Barb, 1/16" (1.6 mm) ID Tubing, (May be used with separate rotating lock ring; FSLLR)



MLRLB220 (-1)

Male Luer Panel Mount 10-32 UNF to 200 Series Barb, 3/32" (2.4 mm) ID Tubing, (May be used with separate rotating lock ring; FSLLR)



MLRLB230 (-1)

Male Luer Panel Mount 1/4-28 UNF to 200 Series Barb, 1/8" (3.2 mm) ID Tubing, (May be used with separate rotating lock ring; FSLLR)



PANEL MOUNT ACCESSORIES:
Lock Nuts and Color Coding Rings

CCR (-1 -2 -3 -07)

Color Coded Ring (For use with PMS, PMK, FTLLB or FTLB panel mount fittings)



CCLR (-1 -2 -3 -4 -5 -06 -07)

Color Coded Lock Ring (For use with PMS, PMK, FTLLB or FTLB panel mount fittings)



PMKN (-XO)

Panel Mount Nut 10-32 UNF with 3/8" Hex (For use with PMK panel mount fittings)



PMSN (-XO)

Panel Mount Nut 1/4-28 UNF with 7/16" Hex (For use with PMS, FTLB, and FTLLB panel mount fittings)



LNS (-1 -2 -3 -5 -J2A)

1/4-28 UNF Panel Mount Lock Nut (For use with PMS, FTLLB or FTLB panel mount fittings)



Select the Correct Lock Nut for Your Panel Mount:

PART	Dimension A	Use Lock Nut
FTLLB Series	.255"	PMSN or LNS
FTLB Series	.255"	PMSN or LNS
FTLLBMLRL	.255"	PMSN or LNS
MLRLB210	.193"	PMKN
MLRLB220	.193"	PMKN
MLRLB230	.255"	PMSN or LNS

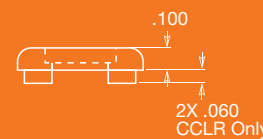
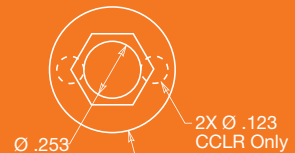
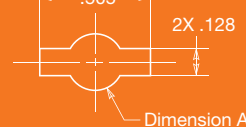
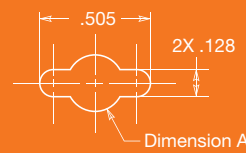
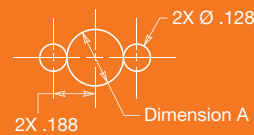

TUBE

FITTINGS



Straight Throughs
PG-21



Straight Through Reducers
PG-22



Elbows
PG-24



Elbow Reducers
PG-25



Tees
PG-25



Tee Reducers
PG-26



Ys
PG-28



Multiports
PG-29



Press-In Plugs
PG-30



Ultrasonically Weldable Barbs
PG-31



Panel Mounts & Accessories
PG-31



Large Tube Fittings
PG-95



Nordson MEDICAL offers barbed tube fittings and tubing connectors in sizes ranging from 1/16" (1.6 mm) to 1.5" (38.1 mm) tubing ID in over 100 separate configurations in nylon, polypropylene, polycarbonate and PVDF, with other engineering resins available on special order. Available barbed fitting styles include straight tube connectors, elbow fittings, tee fittings, crosses, Y (wye) connectors, multi-port connectors, and multiple straight, elbow and tee reducer combinations.

Several barb styles are offered to provide designers the widest range of assembly forces, pull-off resistance and blow-off resistance – without the need for clamps. Review the descriptions for each of the styles to determine what's best for your application.

Small Bore Barb Styles

Tube ID	Classic	200 Series	400 Series	500 Series
1/16" (1.6 mm)	X	X	X	X
3/32" (2.4 mm)	X	X	X	X
1/8" (3.2 mm)	X	X	X	X
5/32" (4.0 mm)	X	X	X	X
3/16" (4.8 mm)	X	X	X	X
1/4" (6.4 mm)	X	X	X	X
5/16" (8.0 mm)				X

Large Bore Barb Styles

Tube ID	500 Series	600 Series	900 Series
3/8" (9.5 mm)	X	X	X
1/2" (12.7 mm)	X	X	X
5/8" (16.0 mm)	X	X	
3/4" (19.0 mm)	X	X	
1" (25.4 mm)	X	X	
1.5" (38.1 mm)		X	

TUBE FITTINGS: Straight Through

AA (-1 -6005)

Straight Through Connector with Classic Series Barbs, 1/16" (1.6 mm) ID Tub-



N210 (-1 -2 -6005 -9)

Straight Through Connector with 200 Series Barbs, 1/16" (1.6 mm) ID Tubing



N410 (-1 -6005)

Straight Through Connector with 400 Series Barbs, 1/16" (1.6 mm) ID Tubing



N004 (-6005 -9 -J2A)

Straight Through Connector with 500 Series Barbs, 1/16" (1.6 mm) ID Tubing



DD (-1 -2 -6005 -9)

Straight Through Connector with Classic Series Barbs, 3/32" (2.4 mm) ID Tub-



N220 (-1 -6005 -9)

Straight Through Connector with 200 Series Barbs, 3/32" (2.4 mm) ID Tubing



N420 (-1 -6005 -J2A)

Straight Through Connector with 400 Series Barbs, 3/32" (2.4 mm) ID Tubing



N007 (-1 -2)

Straight Through Connector with 500 Series Barbs, 3/32" (2.4 mm) ID Tubing



CC (-1 -6005)

Straight Through Connector with Classic Series Barbs, 1/8" (3.2 mm) ID Tubing



N230 (-1 -2 -3 -5 -6005 -9 -J2A)

Straight Through Connector with 200 Series Barbs, 1/8" (3.2 mm) ID Tubing

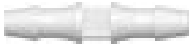

N430 (-1 -6005)

Straight Through Connector with 400 Series Barbs, 1/8" (3.2 mm) ID Tubing



N013 (-1 -6005 -9 -J2A -9002)

Straight Through Connector with 500 Series Barbs, 1/8" (3.2 mm) ID Tubing



4040 (-1 -2 -6005 -J2A)

Straight Through Connector with Classic Series Barbs, 5/32" (4.0 mm) ID Tubing



N440 (-6005 -J2A)

Straight Through Connector with 400 Series Barbs, 5/32" (4.0 mm) ID Tubing



N025 (-1 -6005)

Straight Through Connector with 500 Series Barbs, 5/32" (4.0 mm) ID Tubing



5050 (-1 -2 -6005 -9002)

Straight Through Connector with Classic Series Barbs, 3/16" (4.8 mm) ID Tubing



N035 (-1 -6005 -J2A)

Straight Through Connector with 500 Series Barbs, 3/16" (4.8 mm) ID Tubing

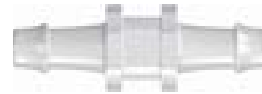

6060 (-6005 -9 -J2A)

Straight Through Connector with Classic Series Barbs, 1/4" (6.4 mm) ID Tubing



N055 (-2 -6005 -9)

Straight Through Connector with 500 Series Barbs, 1/4" (6.4 mm) ID Tubing



N065 (-2)

Straight Through Connector with 500 Series Barbs, 5/16" (8 mm) ID Tubing



Need Larger Fittings?

You can find tube fittings for 3/8" (9.5 mm) ID tubing and larger in our selection of BioProcessing Fittings beginning on [page 95](#) and online at www.nordsonmedical.com.

TUBE FITTINGS: Straight Through Reducer

AD (-1 -6005 -J2A)

Straight Through Reduction Connector with Classic Series Barbs, 3/32" (2.4 mm) and 1/16" (1.6 mm) ID Tubing



N220/210 (-1 -6005)

Straight Through Reduction Connector with 200 Series Barbs, 3/32" (2.4 mm) and 1/16" (1.6 mm) ID Tubing



N420/410 (-1 -6005 -10)

Straight Through Reduction Connector with 400 Series Barbs, 3/32" (2.4 mm) and 1/16" (1.6 mm) ID Tubing



N007/004 (-6005 -J2A)

Straight Through Reduction Connector with 500 Series Barbs, 3/32" (2.4 mm) and 1/16" (1.6 mm) ID Tubing



AC (-0 -1 -2 -6005 -J2A)

Straight Through Reduction Connector with Classic Series Barbs, 1/8" (3.2 mm) and 1/16" (1.6 mm) ID Tubing



N230/210 (-1 -6005 -9)

Straight Through Reduction Connector with 200 Series Barbs, 1/8" (3.2 mm) and 1/16" (1.6 mm) ID Tubing



N430/410 (-1)

Straight Through Reduction Connector with 400 Series Barbs, 1/8" (3.2 mm) and 1/16" (1.6 mm) ID Tubing



N013/004 (-1 -2 -6005 -9)

Straight Through Reduction Connector with 500 Series Barbs, 1/8" (3.2 mm) and 1/16" (1.6 mm) ID Tubing



DC (-1 -6005 -9)

Straight Through Reduction Connector with Classic Series Barbs, 1/8" (3.2 mm) and 3/32" (2.4 mm) ID Tubing



N230/220 (-1 -6005 -07 -9 -J2A)

Straight Through Reduction Connector with 200 Series Barbs, 1/8" (3.2 mm) and 3/32" (2.4 mm) ID Tubing



N430/420 (-1 -2 -6005 -6012)

Straight Through Reduction Connector with 400 Series Barbs, 1/8" (3.2 mm) and 3/32" (2.4 mm) ID Tubing



N013/007 (-1 -2 -6005 -6012 -9002)

Straight Through Reduction Connector with 500 Series Barbs, 1/8" (3.2 mm) and 3/32" (2.4 mm) ID Tubing



1040 (-1 -6005 -9)

Straight Through Reduction Connector with Classic Series Barbs, 5/32" (4.0 mm) and 1/16" (1.6 mm) ID Tubing



N025/004 (-1 -2)

Straight Through Reduction Connector with 500 Series Barbs, 5/32" (4.0 mm) and 1/16" (1.6 mm) ID Tubing



2040 (-1 -6005 -9)

Straight Through Reduction Connector with Classic Series Barbs, 5/32" (4.0 mm) and 3/32" (2.4 mm) ID Tubing



N025/007 (-9)

Straight Through Reduction Connector with 500 Series Barbs, 5/32" (4.0 mm) and 3/32" (2.4 mm) ID Tubing



3040 (-1 -2 -6005 -9 -J2A)

Straight Through Reduction Connector with Classic Series Barbs, 5/32" (4.0 mm) and 1/8" (3.2 mm) ID Tubing



N025/013 (-9 -J2A)

Straight Through Reduction Connector with 500 Series Barbs, 5/32" (4.0 mm) and 1/8" (3.2 mm) ID Tubing



2050 (-6005)

Straight Through Reduction Connector with Classic Series Barbs, 3/16" (4.8 mm) and 3/32" (2.4 mm) ID Tubing



N035/007 (-2 -9)

Straight Through Reduction Connector with 500 Series Barbs, 3/16" (4.8 mm) and 3/32" (2.4 mm) ID Tubing



TUBE FITTINGS: Straight Through Reducer

3050 (-1 -6005 -81 -9 -J2A)

Straight Through Reduction Connector with Classic Series Barbs, 3/16" (4.8 mm) and 1/8" (3.2 mm) ID Tubing



N035/013 (-6005 -81)

Straight Through Reduction Connector with 500 Series Barbs, 3/16" (4.8 mm) and 1/8" (3.2 mm) ID Tubing



4050 (-2 -6005 -9 -J2A)

Straight Through Reduction Connector with Classic Series Barbs, 3/16" (4.8 mm) and 5/32" (4.0 mm) ID Tubing



N035/025 (-2 -6005 -9)

Straight Through Reduction Connector with 500 Series Barbs, 3/16" (4.8 mm) and 5/32" (4.0 mm) ID Tubing



3060 (-1 -6005 -9 -J2A)

Straight Through Reduction Connector with Classic Series Barbs, 1/4" (6.4 mm) and 1/8" (3.2 mm) ID Tubing



N055/013 (-6005 -J2A)

Straight Through Reduction Connector with 500 Series Barbs, 1/4" (6.4 mm) and 1/8" (3.2 mm) ID Tubing



4060 (-1 -6005 -J2A)

Straight Through Reduction Connector with Classic Series Barbs, 1/4" (6.4 mm) and 5/32" (4.0 mm) ID Tubing



N055/025 (-1 -2 -6005)

Straight Through Reduction Connector with 500 Series Barbs, 1/4" (6.4 mm) and 5/32" (4.0 mm) ID Tubing



5060 (-1 -6005 -9 -9002 -J2A)

Straight Through Reduction Connector with Classic Series Barbs, 1/4" (6.4 mm) and 3/16" (4.8 mm) ID Tubing



N055/035 (-2 -6005)

Straight Through Reduction Connector with 500 Series Barbs, 1/4" (6.4 mm) and 3/16" (4.8 mm) ID Tubing



N065/035 (-6005)

Straight Through Reduction Connector with 500 Series Barbs, 5/16" (8.0 mm) and 3/16" (4.8 mm) ID Tubing



N065/055 (-1 -6005)

Straight Through Reduction Connector with 500 Series Barbs, 5/16" (8.0 mm) and 1/4" (6.4 mm) ID Tubing



Need Larger Fittings?

You can find tube fittings for 3/8" (9.5 mm) ID tubing and larger in our selection of BioProcessing Fittings beginning on [page 95](#) and online at www.nordsonmedical.com.

Part Drawings Online!

Nordson MEDICAL provides dimensional drawings available for download for all of its fittings. www.nordsonmedical.com

TUBE FITTINGS: Elbow

L10 (-2 -6005)

Elbow Connector with Classic Series Barbs, 1/16" (1.6 mm) ID Tubing



L210 (-1 -2 -6005)

Elbow Connector with 200 Series Barbs, 1/16" (1.6 mm) ID Tubing



L410 (-1 -6005)

Elbow Connector with 400 Series Barbs, 1/16" (1.6 mm) ID Tubing



L20 (-6005)

Elbow Connector with Classic Series Barbs, 3/32" (2.4 mm) ID Tubing



L220 (-1 -6005 -6012 -9002)

Elbow Connector with 200 Series Barbs, 3/32" (2.4 mm) ID Tubing



L420 (-1 -6005 -J2A)

Elbow Connector with 400 Series Barbs, 3/32" (2.4 mm) ID Tubing



L30 (-1 -2 -6005)

Elbow Connector with Classic Series Barbs, 1/8" (3.2 mm) ID Tubing



L230 (-1 -2 -6005 -J2A)

Elbow Connector with 200 Series Barbs, 1/8" (3.2 mm) ID Tubing



L430 (-1 -2 -6005)

Elbow Connector with 400 Series Barbs, 1/8" (3.2 mm) ID Tubing



L40 (-1 -6005)

Elbow Connector with Classic Series Barbs, 5/32" (4.0 mm) ID Tubing



L440 (-2)

Elbow Connector with 400 Series Barbs, 5/32" (4.0 mm) ID Tubing



L50 (-1 -6005)

Elbow Connector with Classic Series Barbs, 3/16" (4.8 mm) ID Tubing



L60 (-1 -6005)

Elbow Connector with Classic Series Barbs, 1/4" (6.4 mm) ID Tubing



Technical Assistance

Trying to choose the correct part? Need more material information than is published in this catalog? Call Nordson MEDICAL Technical Support **(970) 267-5200**.

TUBE FITTINGS: Elbow Reducer

L220/210 (-1 -6005 -9)

Elbow Reduction Connector with 200 Series Barbs, 3/32" (2.4 mm) and 1/16" (1.6 mm) ID Tubing



L230/210 (-1 -2 -6005 -J2A)

Elbow Reduction Connector with 200 Series Barbs, 1/8" (3.2 mm) and 1/16" (1.6 mm) ID Tubing



L230/220 (-1 -2 -6005 -9)

Elbow Reduction Connector with 200 Series Barbs, 1/8" (3.2 mm) and 3/32" (2.4 mm) ID Tubing



L430/420 (-1 -2)

Elbow Reduction Connector with 400 Series Barbs, 1/8" (3.2 mm) and 3/32" (2.4 mm) ID Tubing



Custom Assembly

We produce standard components to fit your current assemblies and devices, but we also provide custom solutions by applying a variety of assembly options, such as joining fittings, connectors, filters, and other components to tubing. From systems using a single fitting to complex configurations utilizing various components, we can design complete assemblies to your requirements.

Need Larger Fittings?

You can find tube fittings for 3/8" (9.5 mm) ID tubing and larger in our selection of BioProcessing Fittings beginning on [page 95](#) and online at www.nordsonmedical.com.

TUBE FITTINGS: Tee

T10 (-1 -6005)

Tee Connector with Classic Series Barbs, 1/16" (1.6 mm) ID Tubing



T210 (-1 -2 -6005)

Tee Connector with 200 Series Barbs, 1/16" (1.6 mm) ID Tubing



T410 (-1)

Tee Connector with 400 Series Barbs, 1/16" (1.6 mm) ID Tubing



T20 (-1 -6005)

Tee Connector with Classic Series Barbs, 3/32" (2.4 mm) ID Tubing



T220 (-1 -6005 -6012)

Tee Connector with 200 Series Barbs, 3/32" (2.4 mm) ID Tubing



T420 (-1 -6005 -J2A)

Tee Connector with 400 Series Barbs, 3/32" (2.4 mm) ID Tubing



T30 (-1 -2 -6005 -9)

Tee Connector with Classic Series Barbs, 1/8" (3.2 mm) ID Tubing



Need Samples for Evaluation?

You can call to request most of our standard product in quantities of 5, or less, for free application evaluation.
+1 (970) 267-5200 Toll Free: (888) 404-5837

TUBE FITTINGS:

Tee

T230 (-1 -2 -6005 -J2A)

Tee Connector with 200 Series Barbs, 1/8" (3.2 mm) ID Tubing



T430 (-6005 -9002 -J2A)

Tee Connector with 400 Series Barbs, 1/8" (3.2 mm) ID Tubing



T013 (-6005)

Tee Connector with 500 Series Barbs, 1/8" (3.2 mm) ID Tubing



T40 (-1 -6005)

Tee Connector with Classic Series Barbs, 5/32" (4 mm) ID Tubing



T250 (-2 -6005)

Tee Connector with 200 Series Barbs, 3/16" (4.8 mm) ID Tubing



T60 (-1 -2 -6005)

Tee Connector with Classic Series Barbs, 1/4" (6.4 mm) ID Tubing



T055 (-6005)

Tee Connector with 500 Series Barbs, 1/4" (6.4 mm) ID Tubing



TUBE-TO-TUBE
FITTINGS

TUBE FITTINGS:

Tee Reducer

T410/420 (-2 -6005)

Tee Reduction Connector with 400 Series Barbs, 1/16" (1.6 mm) and 3/32" (2.4 mm) ID Tubing

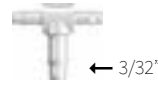

T210/230 (-1 -6005 -9)

Tee Reduction Connector with 200 Series Barbs, 1/16" (1.6 mm) and 1/8" (3.2 mm) ID Tubing

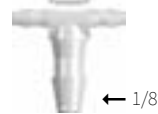

T410/430 (-2 -6005)

Tee Reduction Connector with 400 Series Barbs, 1/16" (1.6 mm) and 1/8" (3.2 mm) ID Tubing

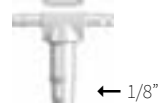

T220/210 (-1 -2 -6005 -9)

Tee Reduction Connector with 200 Series Barbs, 3/32" (2.4 mm) and 1/16" (1.6 mm) ID Tubing

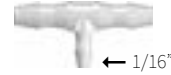

T220R210 (-2 -9)

Tee Reduction Connector with 200 Series Barbs, 3/32" (2.4 mm) and 1/16" (1.6 mm) ID Tubing



T420/410 (-2)

Tee Reduction Connector with 400 Series Barbs, 3/32" (2.4 mm) and 1/16" (1.6 mm) ID Tubing



T420R410 (-1 -2)

Tee Reduction Connector with 400 Series Barbs, 3/32" (2.4 mm) and 1/16" (1.6 mm) ID Tubing



T210/220 (-6005 -9)

Tee Reduction Connector with 200 Series Barbs, 3/32" (2.4 mm) and 1/16" (1.6 mm) ID Tubing



T220/230 (-1 -6005 -9)

Tee Reduction Connector with 200 Series Barbs, 3/32" (2.4 mm) and 1/8" (3.2 mm) ID Tubing



TUBE FITTINGS: Tee Reducer

T230/210 (-1 -2 -6005 -J2A)

Tee Reduction Connector with 200 Series Barbs, 1/8" (3.2 mm) and 1/16" (1.6 mm) ID Tubing

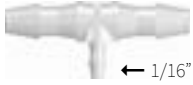

T230R210 (-1)

Tee Reduction Connector with 200 Series Barbs, 1/8" (3.2 mm) and 1/16" (1.6 mm) ID Tubing



T430/410 (-2)

Tee Reduction Connector with 400 Series Barbs, 1/8" (3.2 mm) and 1/16" (1.6 mm) ID Tubing

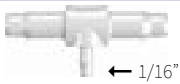

T430R410 (-1 -2 -6005)

Tee Reduction Connector with 400 Series Barbs, 1/8" (3.2 mm) and 1/16" (1.6 mm) ID Tubing

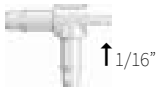

T230/220 (-1 -2 -6005 -9 -J2A)

Tee Reduction Connector with 200 Series Barbs, 1/8" (3.2 mm) and 3/32" (2.4 mm) ID Tubing

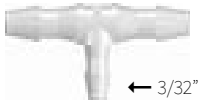

T230R220 (-9)

Tee Reduction Connector with 200 Series Barbs, 1/8" (3.2 mm) and 3/32" (2.4 mm) ID Tubing



T430/420 (-1 -2 -3)

Tee Reduction Connector with 400 Series Barbs, 1/8" (3.2 mm) and 3/32" (2.4 mm) ID Tubing

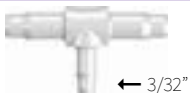

T360/220 (-2 -6005 -9)

Tee Reduction Connector with 200 and 300 Series Barbs, 1/4" (6.4 mm) and 3/32" (2.4 mm) ID Tubing



T360/230 (-1 -6005 -9)

Tee Reduction Connector with 200 and 300 Series Barbs, 1/4" (6.4 mm) and 1/8" (3.2 mm) ID Tubing



T360/250 (-1 -2 -9)

Tee Reduction Connector with 200 and 300 Series Barbs, 1/4" (6.4 mm) and 3/16" (4.8 mm) ID Tubing



Need Larger Fittings?

You can find tube fittings for 3/8" (9.5 mm) ID tubing and larger in our selection of BioProcessing Fittings beginning on **page 95** and online at www.nordsonmedical.com.

Need More Details?

Part drawings, minimum order quantities, and CAD requests can be found online. Visit www.nordsonmedical.com or contact Sales at Orders@nordsonmedical.com.

Y210 (-1 -2 -6005 -9 -J2A)

Y Connector with 200 Series Barbs, 1/16" (1.6 mm) ID Tubing

**Y410 (-6005)**

Y Connector with 400 Series Barbs, 1/16" (1.6 mm) ID Tubing

**Y220 (-1 -2 -6005 -9 -J2A)**

Y Connector with 200 Series Barbs, 3/32" (2.4 mm) ID Tubing

**Y420 (-1 -6005)**

Y Connector with 400 Series Barbs, 3/32" (2.4 mm) ID Tubing

**Y230 (-1 -2 -6005 -9 -9002 -9010 -J2A)**

Y Connector with 200 Series Barbs, 1/8" (3.2 mm) ID Tubing

**Y430 (-1 -2 -6005 -J2A)**

Y Connector with 400 Series Barbs, 1/8" (3.2 mm) ID Tubing

**Y013 (-6005)**

Y Connector with 500 Series Barbs, 1/8" (3.2 mm) ID Tubing

**Y240 (-1 -6005 -9 -J2A)**

Y Connector with 200 Series Barbs, 5/32" (4.0 mm) ID Tubing

**Y250 (-1 -6005 -9 -J2A)**

Y Connector with 200 Series Barbs, 3/16" (4.8 mm) ID Tubing

**Y450 (-1 -6005 -6012)**

Y Connector with 400 Series Barbs, 3/16" (4.8 mm) ID Tubing

**Y260 (-1 -2 -6005 -9 -9002 -J2A)**

Y Connector with 200 Series Barbs, 1/4" (6.4 mm) ID Tubing

**Y460 (-1 -6005 -9 -J2A)**

Y Connector with 400 Series Barbs, 1/4" (6.4 mm) ID Tubing

**Y055 (-6005)**

Y Connector with 500 Series Barbs, 1/4" (6.4 mm) ID Tubing



TUBE FITTINGS: Multiport

3PF210 (-6005)

Three-Port F Style Manifold with 200 Series Barbs for 1/16" (1.6 mm) ID Tubing



3PF220 (-6005)

Three-Port F Style Manifold with 200 Series Barbs for 3/32" (2.4 mm) ID Tubing



3PF230 (-1 -6005)

Three-Port F Style Manifold with 200 Series Barbs for 1/8" (3.2 mm) ID Tubing



4PX210 (-1 -6005)

Four-Port Cross Style Manifold with 200 Series Barbs for 1/16" (1.6 mm) ID Tubing

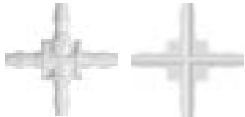

4PX220 (-1 -6005)

Four-Port Cross Style Manifold with 200 Series Barbs for 3/32" (2.4 mm) ID Tubing



4PX230 (-1 -6005)

Four-Port Cross Style Manifold with 200 Series Barbs for 1/8" (3.2 mm) ID Tubing



4PDL220 (-1)

Four-Port Double Elbow Style Manifold with 200 Series Barbs, 3/32" (2.4 mm) ID Tubing



4PLL210 (-6005)

Four-Port Thru Flow Double Elbow Style Manifold with 200 Series Barbs, 1/16" (1.6 mm) ID Tubing



4PLL220 (-1 -6005 -9)

Four-Port Thru Flow Double Elbow Style Manifold with 200 Series Barbs, 3/32" (2.4 mm) ID Tubing



4PLL230 (-1 -2 -6005)

Four-Port Thru Flow Double Elbow Style Manifold with 200 Series Barbs, 1/8" (3.2 mm) ID Tubing



6PDT220 (-6005)

Six-Port Double T Style Manifold with 200 Series Barbs for 3/32" (2.4 mm) ID Tubing

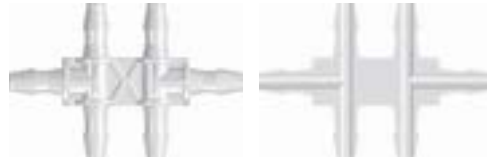

6PDT230 (-1)

Six-Port Double T Style Manifold with 200 Series Barbs for 1/8" (3.2 mm) ID Tubing



6PTT230 (-6005)

Six-Port Thru Flow Double T Style Manifold with 200 Series Barbs for 1/8" (3.2 mm) ID Tubing



Need Larger Fittings?

You can find tube fittings for 3/8" (9.5 mm) ID tubing and larger in our selection of BioProcessing Fittings beginning on [page 95](#) and online at www.nordsonmedical.com.

TUBE FITTINGS: Press-In Plugs

PIP10 (-1)

Press-In Plug with Classic Series Barb, 1/16" (1.6 mm) ID Tubing



PIP210 (-2)

Press-In Plug with 200 Series Barb, 1/16" (1.6 mm) ID Tubing



PIP20 (-6005)

Press-In Plug with Classic Series Barb, 3/32" (2.4 mm) ID Tubing



PIP220 (-1 -6005 -6012 -J2A)

Press-In Plug with 200 Series Barb, 3/32" (2.4 mm) ID Tubing



PIP30 (-6005 -J2A)

Press-In Plug with Classic Series Barb, 1/8" (3.2 mm) ID Tubing



PIP230 (-1 -6005 -6012 -J2A)

Press-In Plug with 200 Series Barb, 1/8" (3.2 mm) ID Tubing



PIP40 (-6005)

Press-In Plug with Classic Series Barb, 5/32" (4.0 mm) ID Tubing



PIP240 (-1 -2)

Press-In Plug with 200 Series Barb, 5/32" (4.0 mm) ID Tubing



PIP50 (-1 -6005)

Press-In Plug with Classic Series Barb, 3/16" (4.8 mm) ID Tubing



PIP60 (-6005 -J2A)

Press-In Plug with Classic Series Barb, 1/4" (6.4 mm) ID Tubing



Looking for Something Different?

Most of our best product ideas have come from you, our customers. While we pride ourselves on our extensive product offering, we recognize that your needs are ever-changing and that our products, too, must adapt to your needs.

If there's a new product you think Nordson MEDICAL should make, please send us an Email at Orders@nordsonmedical.com describing your product concept in as much detail as you desire. We will contact you with any questions, and who knows - the next catalog edition could include products YOU told us to build.

See page 8-9 for more information on custom engineered solutions!



TUBE FITTINGS:
Ultrasonically Weldable Barb

U10 (-1 -2 -9)

Ultrasonically Weldable Fitting to Classic Series Barb, 1/16" (1.6 mm) ID Tubing



U20 (-1 -7)

Ultrasonically Weldable Fitting to Classic Series Barb, 3/32" (2.4 mm) ID Tubing



U30 (-1 -7)

Ultrasonically Weldable Fitting to Classic Series Barb, 1/8" (3.2 mm) ID Tubing



TUBE FITTINGS PANEL MOUNTS:
Straight Through and Reducer

PMK210 (-1 -6005)

Panel Mount Connector 10-32 UNF to 200 Series Barbs, 1/16" (1.6 mm) ID Tubing



PMK220 (-1 -6005 -J2A)

Panel Mount Connector 10-32 UNF to 200 Series Barbs, 3/32" (2.4 mm) ID Tubing



PMS230 (-1 -6005)

Panel Mount Connector 1/4-28 UNF to 200 Series Barbs, 1/8" (3.2 mm) ID Tubing



PMS230-210 (-1)

Panel Mount Reduction Connector 1/4-28 UNF to 200 Series Barbs, 1/8" (3.2 mm) and 1/16" (1.6 mm) ID Tubing



TUBE FITTINGS PANEL MOUNT ACCESSORIES:
Lock Nuts and Color Coding Rings

CCLR (-1 -2 -3 -4 -5 -06 -07)

Color Coded Lock Ring
(For use with PMS, PMK, FTLLB or FTLB panel mount fittings)



PMKN (-XO)

Panel Mount Nut 10-32 UNF with 3/8" Hex
(For use with PMK panel mount fittings)



PMSN (-XO)

Panel Mount Nut 1/4-28 UNF with 7/16" Hex
(For use with PMS, FTLB, and FTLLB panel mount fittings)



LNS (-1 -2 -3 -4 -5 -06 -07 -J2A)

1/4-28 UNF Panel Mount Lock Nut
(For use with PMS, FTLLB or FTLB panel mount fittings)



Select the Correct Lock Nut for Your Panel Mount:

PART	Dimension A	Use Lock Nut
PMK Series	.193"	PMKN
PMS Series	.255"	PMSN or LNS

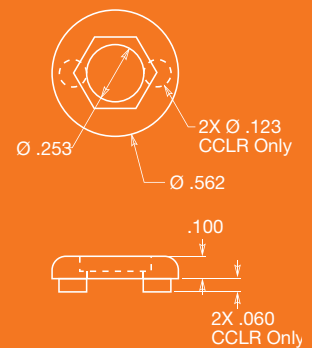
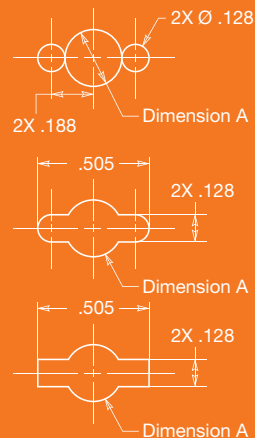

ISO 80369

COMPLIANT CONNECTORS

ISO 80369-3 (Enteral) Compliant Connectors PG-33



ISO 80369-5 (Blood Pressure) Compliant Connectors PG-33



ISO 80369-6 (Neuraxial) Compliant Connectors PG-34



ISO 80369-7 (Intravascular) Compliant Connectors PG-34



What is ISO 80369

Hospitals and other healthcare facilities depend on a variety of catheters, tubing and syringes to deliver medications and other substances to patients through vascular, enteral, respiratory, epidural and intrathecal delivery systems. These delivery systems frequently employ fittings called luer connectors to link various system components. Unfortunately, because luer connectors are ubiquitous, easy-to-use, and compatible between different delivery systems, end users can inadvertently connect the incorrect systems together. These misconnections can cause medication or other fluids to be delivered through the wrong route, resulting in serious patient injuries and even death. In an effort to reduce the occurrence of these misconnections, the FDA is in collaboration with the International Organization for Standardization (ISO) and the Association for the Advancement of Medical Instrumentation (AAMI) to develop standards for the non-interconnectability of small bore medical connectors. A joint working group established by the International Organization for Standardization (ISO) and the International Electrotechnical Commission (IEC) leads this effort to develop a series of standards for incompatible connectors.

Nordson MEDICAL is well positioned to help you with your tubing connection needs. Our parts are designed, tested, qualified, and documented to be compliant with these new standards. Because Nordson MEDICAL's Value Plastics product line team has participated on the committees developing these standards, you can be assured of a full understanding of the testing and compliance requirements.

Part Drawings Online!

Nordson MEDICAL provides dimensional drawings available for download for all of its fittings.

www.nordsonmedical.com

ISO 80369-1

General Requirements

The ISO 80369-1 standard provides general requirements to prevent misconnections between small-bore connectors used in various medical devices.

ISO 80369-2

Breathing Systems and Driving Gases

Respiratory applications include connectors designed for low flow, such as flowmeters, nebulizers, nasal cannulae, and ventilators. This application aims to interact with the human body's airways in various modalities.

ISO 80369-3

Enteral

Enteral and gastric applications drive the requirements for these connectors, which have a larger bore than standard luers. The goal of this application is to deliver nutrition directly to the patient when normal eating is not possible.

ISO 80369-3 COMPLIANT PARTS: Enteral

ENTFTC (-VP1)

Tethered Cap, Fits Enteral Male Connector, Animal-Free Polyethylene



COMPLIANT

ENTM230 (-6005)

Enteral Male Connector with Barb for 1/8" (3.2 mm) ID Tubing, Animal-Free Polypropylene



COMPLIANT

ISO 80369-4

Urinary (Urethral)

This section of ISO 80369 is yet to be published (as of 2023), but will aim to define the connectors associated with urinary and urethral devices with the purpose of draining urine from the bladder.

ISO 80369-5

Limb Cuff and Blood Pressure

Limb cuff inflation includes blood pressure monitoring and tourniquets, inflating devices external to the human body. These connectors are characterized by smaller bores to not misconnect with other devices that interact with the body.

ISO 80369-5 COMPLIANT PARTS: Limb Cuff and Blood Pressure

BPM013 (-1)

Blood Pressure Monitor Bayonet Connector to 500 Series Barb, 80369-5 Compliant, 1/8" (3.2 mm) ID Tubing



COMPLIANT

BPM240 (-1)

Blood Pressure Monitor Bayonet Connector to 200 Series Barb, 80369-5 Compliant, 5/32" (4.0 mm) ID Tubing



COMPLIANT

BPM025 (-1)

Blood Pressure Monitor Bayonet Connector to 500 Series Barb, 80369-5 Compliant, 5/32" (4.0 mm) ID Tubing



COMPLIANT

BPM035 (-1, 1A)

Blood Pressure Monitor Bayonet Connector to 500 Series Barb, 80369-5 Compliant, 3/16" (4.8 mm) ID Tubing



COMPLIANT

BPMB230 (-1)

Blood Pressure Monitor Bayonet Panel Mount Connector to 200 Series Barb, 80369-5 Compliant, 1/4-28 UNF Thread, 1/8" (3.2 mm) ID Tubing



COMPLIANT

ISO 80369-6

Neuraxial

Neuraxial applications are designed around anesthesia and spinal fluid procedures. This includes intrathecal injections, epidural infusions, nerve blocks, peripheral infusions and cerebro-spinal fluid drainage.

ISO
80369

ISO 80369-6 COMPLIANT PARTS: Neuraxial

NEFC-50

Neuraxial Female Cap, Fits Neuraxial Male Connector, Clear Acrylic



COMPLIANT

NEFC-8012

Neuraxial Female Cap, Fits Neuraxial Male Connector, White ABS



COMPLIANT

NEFCV-50

Neuraxial Female Vented Cap, Fits Neuraxial Male Connector, Clear Acrylic



COMPLIANT

NEFCV-9010

Neuraxial Female Vented Cap, Fits Neuraxial Male Connector, Polycarbonate



COMPLIANT

NEFE21-9010

Neuraxial Female Connector, 2.1 mm Tubing Bond-In Pocket, Polycarbonate



COMPLIANT

NEFE31-9010

Neuraxial Female Connector, 3.1 mm Tubing Bond-In Pocket, Polycarbonate

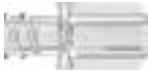

COMPLIANT

NEME31-9010

Neuraxial Male Connector, 2.1 mm Tubing, Bond-In Pocket, Polycarbonate



COMPLIANT

NEMP-50

Neuraxial Male Plug, Fits Neuraxial Female Connector, Clear Acrylic



COMPLIANT

ISO 80369-7

Intravascular and Hypodermic

Intended for intravascular (I.V.) and hypodermic applications, the publication supersedes the legacy ISO 594 standard, which defined tapered luer connectors historically.

ISO 80369-7 COMPLIANT PARTS: Intravascular and Hypodermic

FCVFFM-008

3-Way Stopcock, Female Luer to Female Luer to Male Luer, 80369-7 Compliant, Clear Polycarbonate Body, Natural HDPE Diverter



COMPLIANT

FCVFM-001

1-Way Low-Pressure Stopcock, Female Luer to Male Luer, 80369-7 Compliant, Radiation-Stable Polycarbonate Body, Natural HDPE Diverter

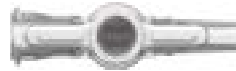

COMPLIANT

MTLLPV-6005

Male Luer Integral Lock Ring Plug, Closed at Grip, 80369-7 Compliant, Clear Polycarbonate



COMPLIANT

Custom Assembly

We produce standard components to fit your current assemblies and devices, but we also provide custom solutions by applying a variety of assembly options, such as joining fittings, connectors, filters, and other components to tubing. From systems using a single fitting to complex configurations utilizing various components, we can design complete assemblies to your requirements.

PHARMA+™

Tubing Retainers

Experience leak-free fluid transfer like never before with our advanced tubing retainers. Designed to effortlessly secure tubing over hose barbs, our patent-pending retainers feature a revolutionary lead-in ramp ensuring complete 360° compression to prevent leaks, while ribs on both edges provide an extra layer of protection. Crafted for compatibility, they work seamlessly with silicone, TPE, and PVC tubing, making them a versatile choice for biopharm processing and high-pressure medical applications. Their intuitive, clean room-molded design ensures easy, contamination-free assembly, further supported by their recyclable composition. Choose reliability, choose efficiency – choose Pharma+ Tubing Retainers and conquer fluid transfer challenges with confidence.

Features & Benefits:

- Lead-in ramp creates complete 360° compression for leak prevention
- Intuitive design for easy assembly using existing cable tie tension tools
- Three sizes cover a range of tubing IDs and ODs
- Covering of barb edge creates a secure attachment and prevents leaks from ballooned tubing
- Clean room molded to prevent contamination
- Materials meet USP Class VI & ISO 10993 criteria
- Validated plastic material does not corrode
- Recyclable for easy disposal

Specifications:

Material:

- Polyketone (PK)

Tubing ID Sizes:

- TR30/50-PK: 1/8" (3.2 mm) to 3/16" (4.8 mm)
- TR55/70-PK: 1/4" (6.4 mm) to 3/8" (9.5 mm)
- TR80/100-PK: 1/2" (12.7 mm) to 3/4" (19.0 mm)
Coming Soon

Tubing OD Sizes:

- TR30/50-PK: 1/4" (6.4 mm) to 7/16" (11.1 mm)
- TR55/70-PK: 3/8" (9.5 mm) to 5/8" (15.9 mm)
- TR80/100-PK: 5/8" (15.9 mm) to 1-1/8" (28.6 mm)
Coming Soon

Sterilization:

- Gamma radiation up to 50 kGy
- Autoclavable up to 250° F (121° C)
- X-ray sterilization up to 50 kGy

Operating Pressure:

- 80 psi pressure rating to 120 psi burst

PHARMA+ Tubing Retainers

TR30/50-PK5

Tubing Retainer 1/4" (6.4 mm) to 7/16" (11.1 mm) OD Tubing, Polyketone



TR55/70-PK5

Tubing Retainer 3/8" (9.5 mm) to 5/8" (15.9 mm) OD Tubing, Polyketone



TR80/100-PK5 (Coming Soon)

Tubing Retainer 5/8" (15.9 mm) to 1-1/8" (28.6 mm) OD Tubing, Polyketone



QUICK CONNECT

COUPLINGS



10 Series - 1/16"
Flow Size **PG-36**



20 Series - 1/8"
Flow Size **PG-38**



30 Series - 1/8"
Flow Size **PG-45**



33 Series - 1/8"
Flow Size **PG-45**



40 Series - 1/4"
Flow Size **PG-46**



42 Series - 3/32"
Flow Size **PG-50**



50 Series - 1/4"
Flow Size **PG-51**



55 Series - 1/8" - 1/4"
Flow Size **PG-54**



60 Series - 3/8"
Flow Size **PG-54**



65 Series - 1/2"
Flow Size **PG-58**



100 Series - 1/16"
Flow Size **PG-59**



MQC Series
PG-60



RQ Series
PG-61



SBL Series
PG-62



XQ Series
PG-63



Filtration Connectors
PG-64



Our medical quick connect line is incredible -

Quick connect couplings allow you to quickly and easily connect or disconnect fluid transfer lines, without using tools and without disrupting tubing pressure. Sizes range from 1/16" (1.6 mm) to 1/2" (12.7 mm) ID tubing.

10 Series

Quick Connect Couplings

10 SERIES - 1/16" FLOW SIZE: Female Open Flow Straight



Reference part shown: **10AC-S2-02**

10AC-S2-02

LinkTech 10AC Series Straight Female, Non-Valved, 1/8" Hose Barb, Natural Acetal

10AC-S2-02BLK

LinkTech 10AC Series Straight Female, Non-Valved, 1/8" Hose Barb, Black, Acetal

10AC-S2-02NSBLK

LinkTech 10AC Series Straight Female, Non-Valved, 1/8" Hose Barb, No Sleeve, Black, Acetal

10AC-S2-M3BLK

LinkTech 10AC Series Straight Female, Non-Valved, 3 mm Hose Barb, Black, Acetal

10PP-S2-01

LinkTech 10PP Series Straight Female, Non-Valved, 1/16" Hose Barb, Polypropylene

10PP-S2-M3NS

LinkTech 10PP Series Straight Female, Non-Valved, 3 mm Hose Barb, No Sleeve, Polypropylene

Did You Know?

Nordson MEDICAL has an interactive PDF available online at www.nordsonmedical.com. Access part drawings, reference charts, data sheets, and more from just one location!

10 SERIES - 1/16" FLOW SIZE:
Male Open Flow Straight



Reference part shown: 10AC-PB2-02

10AC-PB2-01

LinkTech 10AC Series Straight Male, Non-Valved, 1/16" Hose Barb, Natural Acetal, Buna-N O-ring

10AC-PB2-02

LinkTech 10AC Series Straight Male, Non-Valved, 1/8" Hose Barb, Natural Acetal, Buna-N O-ring

10AC-PB2-02BLK

LinkTech 10AC Series Straight Male, Non-Valved, 1/8" Hose Barb, Black, Acetal, Buna-N O-ring

10AC-PB2-M3

LinkTech 10AC Series Straight Male, Non-Valved, 3 mm Hose Barb, Natural Acetal, Buna-N O-ring

10PP-PE2-01

LinkTech 10PP Series Straight Male, Non-Valved, 1/16" Hose Barb, Polypropylene, EPDM O-ring

10PP-PE2-M3NS

LinkTech 10PP Series Straight Male, Non-Valved, 3 mm Hose Barb, No Sleeve, Polypropylene, EPDM O-ring

10 SERIES - 1/16" FLOW SIZE:
Female Open Flow Panel Mount



Reference part shown: 10AC-S3-02

10AC-S3-01

LinkTech 10AC Series Panel Mount Female, Non-Valved, 1/16" Hose Barb, Natural Acetal

10AC-S3-02

LinkTech 10AC Series Panel Mount Female, Non-Valved, 1/8" Hose Barb, Natural Acetal

10PP-S3-01

LinkTech 10PP Series Panel Mount Female, Non-Valved, 1/16" Hose Barb, Polypropylene

10PP-S3-M3

LinkTech 10PP Series Panel Mount Female, Non-Valved, 3 mm Hose Barb, Polypropylene

10 SERIES - 1/16" FLOW SIZE:
Male Open Flow Panel Mount



Reference part shown: 10AC-PB3-02

10AC-PB3-02

LinkTech 10AC Series Panel Mount Male, Non-Valved, 1/8" Hose Barb, Natural Acetal, Buna-N O-ring

10AC-PB3-M3

LinkTech 10AC Series Panel Mount Male, Non-Valved, 3 mm Hose Barb, Natural Acetal, Buna-N O-ring

10AC-PB3-M3BLK

LinkTech 10AC Series Panel Mount Male, Non-Valved, 3 mm Hose Barb, Black, Acetal, Buna-N O-ring

10PP-PE3-01

LinkTech 10PP Series Panel Mount Male, Non-Valved, 1/16" Hose Barb, Polypropylene, EPDM O-ring

10 SERIES - 1/16" FLOW SIZE:
Female Valved Straight



Reference part shown: 10ACV-SB2-02

10ACV-SB2-01NSBLK

LinkTech 10AC Series Straight Female, Valved, 1/16" Hose Barb, No Sleeve, Black, Acetal, Buna-N O-ring

10ACV-SB2-02

LinkTech 10AC Series Straight Female, Valved, 1/8" Hose Barb, Natural Acetal, Buna-N O-ring

10ACV-SB2-M3

LinkTech 10AC Series Straight Female, Valved, 3 mm Hose Barb, Natural Acetal, Buna-N O-ring

10ACV-SB2-M3BLK

LinkTech 10AC Series Straight Female, Valved, 3 mm Hose Barb, Black, Acetal, Buna-N O-ring

10ACV-SB2-M3NSBLK

LinkTech 10AC Series Straight Female, Valved, 3 mm Hose Barb, No Sleeve, Black, Acetal, Buna-N O-ring

Technical Assistance

Trying to choose the correct part? Need more material information than is published in this catalog? Call Nordson MEDICAL Technical Support (970) 267-5200.

10 SERIES - 1/16" FLOW SIZE: Female Valved Panel Mount



Reference part shown: 10ACV-SB3-02

10ACV-SB3-01

LinkTech 10AC Series Panel Mount Female, Valved, 1/16" Hose Barb, Natural Acetal, Buna-N O-ring

10ACV-SB3-02

LinkTech 10AC Series Panel Mount Female, Valved, 1/8" Hose Barb, Natural Acetal, Buna-N O-ring

10ACV-SB3-M3BLK

LinkTech 10AC Series Panel Mount Female, Valved, 3 mm Hose Barb, Black, Acetal, Buna-N O-ring

QUICK
CONNECTS

10 SERIES - 1/16" FLOW SIZE: Male and Female Sets



Reference part shown: 10AC2-02BLK

10AC2-02BLK

LinkTech 10AC Series Straight Coupling, Non-Valved, 1/8" Hose Barb, Black, Acetal, Buna-N O-ring

10AC2-M3BLK

LinkTech 10AC Series Straight Coupling, Non-Valved, 3 mm Hose Barb, Black, Acetal, Buna-N O-ring

Need Samples for Evaluation?

You can call to request most of our standard product in quantities of 5, or less, for free application evaluation.

+1 (970) 267-5200 Toll Free: (888) 404-5837

Custom Assembly

We produce standard components to fit your current assemblies and devices, but we also provide custom solutions by applying a variety of assembly options, such as joining fittings, connectors, filters, and other components to tubing. From systems using a single fitting to complex configurations utilizing various components, we can design complete assemblies to your requirements.

20Series

Quick Connect Couplings

20 SERIES - 1/8" FLOW SIZE: Female Open Flow Straight



Reference part shown: 20AC-S2-04

20AC-S1-02

LinkTech 20AC Series Male Thread Female, Non-Valved, 1/8" MNPT, Natural Acetal

20AC-S1-02BSPT

LinkTech 20AC Series Male Thread Female, Non-Valved, 1/8" BSPT, Natural Acetal

20AC-S1-04

LinkTech 20AC Series Male Thread Female, Non-Valved, 1/4" MNPT, Natural Acetal

20AC-S2-02

LinkTech 20AC Series Straight Female, Non-Valved, 1/8" Hose Barb, Natural Acetal

20AC-S2-03

LinkTech 20AC Series Straight Female, Non-Valved, 3/16" Hose Barb, Natural Acetal

20AC-S2-04

LinkTech 20AC Series Straight Female, Non-Valved, 1/4" Hose Barb, Natural Acetal

20AC-S9-04

LinkTech 20AC Series Straight Female, Non-Valved, 1/4" PTF, Natural Acetal

20CB-S1-02

LinkTech 20CB Series Male Thread Female, Non-Valved, 1/8" MNPT, Chrome Brass

20CB-S1-02BSPT

LinkTech 20CB Series Male Thread Female, Non-Valved, 1/8" BSPT, Chrome Brass

20CB-S9-04

LinkTech 20CB Series Straight Female, Non-Valved, 1/4" PTF, Chrome Brass

20CB-S9-025

LinkTech 20CB Series Straight Female, Non-Valved, 5/32" PTF, Chrome Brass

20 SERIES - 1/8" FLOW SIZE: Female Open Flow Straight

20PP-S1-02

LinkTech 20PP Series Male Thread Female, Non-Valved, 1/8" NPT, Molded Grey Color, Polypropylene

20PP-S1-04

LinkTech 20PP Series Male Thread Female, Non-Valved, 1/4" NPT, Molded Grey Color, Polypropylene

20PP-S2-02

LinkTech 20PP Series Straight Female, Non-Valved, 1/8" Hose Barb, Molded Grey Color, Polypropylene

20PP-S2-04

LinkTech 20PP Series Straight Female, Non-Valved, 1/4" Hose Barb, Molded Grey Color, Polypropylene

20 SERIES - 1/8" FLOW SIZE: Male Open Flow Straight



Reference part shown: 20AC-PB2-04

20AC-PB1-02

LinkTech 20AC Series Male Thread Male, Non-Valved, 1/8" MNPT, Natural Acetal, Buna-N O-ring

20AC-PB1-02BSPT

LinkTech 20AC Series Male Thread Male, Non-Valved, 1/8" BSPT, Natural Acetal, Buna-N O-ring

20AC-PB2-01

LinkTech 20AC Series Straight Male, Non-Valved, 1/16" Hose Barb, Natural Acetal, Buna-N O-ring

20AC-PB2-02

LinkTech 20AC Series Straight Male, Non-Valved, 1/8" Hose Barb, Natural Acetal, Buna-N O-ring

20AC-PB2-03

LinkTech 20AC Series Straight Male, Non-Valved, 3/16" Hose Barb, Natural Acetal, Buna-N O-ring

20AC-PB2-04

LinkTech 20AC Series Straight Male, Non-Valved, 1/4" Hose Barb, Natural Acetal, Buna-N O-ring

20AC-PB9-04

LinkTech 20AC Series Straight Male, Non-Valved, 1/4" PTF, Natural Acetal, Buna-N O-ring

20CB-PB1-02

LinkTech 20CB Series Male Thread Male, Non-Valved, 1/8" MNPT, Chrome Brass, Buna-N O-ring

20CB-PB1-04

LinkTech 20CB Series Male Thread Male, Non-Valved, 1/4" MNPT, Chrome Brass, Buna-N O-ring

20 SERIES - 1/8" FLOW SIZE: Male Open Flow Straight

20CB-PB1-04BSPT

LinkTech 20CB Series Male Thread Male, Non-Valved, 1/4" BSPT, Chrome Brass, Buna-N O-ring

20CB-PB9-04

LinkTech 20CB Series Straight Male, Non-Valved, 1/4" PTF, Chrome Brass, Buna-N O-ring

20PP-PE2-01MALD

LinkTech 20PP Series Straight Male, Non-Valved, 1/16" Hose Barb, Molded Almond Color, Polypropylene, EPDM O-ring

20PP-PE2-02

LinkTech 20PP Series Straight Male, Non-Valved, 1/8" Hose Barb, Molded Grey Color, Polypropylene, EPDM O-ring

20PP-PE2-02MALD

LinkTech 20PP Series Straight Male, Non-Valved, 1/8" Hose Barb, Molded Almond Color, Polypropylene, EPDM O-ring

20PP-PE2-04

LinkTech 20PP Series Straight Male, Non-Valved, 1/4" Hose Barb, Molded Grey Color, Polypropylene, EPDM O-ring

20PPX-PE1-02

LinkTech 20PP Series Male Thread Male, Non-Valved, 1/8" NPT, Molded Grey Color, Polypropylene, EPDM O-ring

Part Drawings Online!

Nordson MEDICAL provides dimensional drawings available for download for all of its fittings.

www.nordsonmedical.com

Looking for Something Different?

Most of our best product ideas have come from you, our customers. While we pride ourselves on our extensive product offering, we recognize that your needs are ever-changing and that our products, too, must adapt to your needs.

If there's a new product you think Nordson MEDICAL should make, please send us an Email at Orders@nordsonmedical.com describing your product concept in as much detail as you desire. We will contact you with any questions, and who knows - the next catalog edition could include products YOU told us to build.

See page 8-9 for more information on custom engineered solutions!



20 SERIES - 1/8" FLOW SIZE: Female Open Flow Panel Mount



Reference part shown: 20AC-S3-04

20AC-S3-01

LinkTech 20AC Series Panel Mount Female, Non-Valved, 1/16" Hose Barb, Natural Acetal

20AC-S3-02

LinkTech 20AC Series Panel Mount Female, Non-Valved, 1/8" Hose Barb, Natural Acetal

20AC-S3-03

LinkTech 20AC Series Panel Mount Female, Non-Valved, 3/16" Hose Barb, Natural Acetal

20AC-S3-03GS

LinkTech 20AC Series Panel Mount Gasket Seal Female, Non-Valved, 3/16" Hose Barb, Natural Acetal

20AC-S3-04

LinkTech 20AC Series Panel Mount Female, Non-Valved, 1/4" Hose Barb, Natural Acetal

20AC-S8-04

LinkTech 20AC Series Panel Mount Female, Non-Valved, 1/4" PTF, Natural Acetal

20AC-S8-025

LinkTech 20AC Series Panel Mount Female, Non-Valved, 5/32" PTF, Natural Acetal

20CB-S3-02

LinkTech 20CB Series Panel Mount Female, Non-Valved, 1/8" Hose Barb, Chrome Brass

20CB-S8-04

LinkTech 20CB Series Panel Mount Female, Non-Valved, 1/4" PTF, Chrome Brass

20PP-S3-02

LinkTech 20PP Series Panel Mount Female, Non-Valved, 1/8" Hose Barb, Molded Grey Color, Polypropylene

20PP-S3-02MALD

LinkTech 20PP Series Panel Mount Female, Non-Valved, 1/8" Hose Barb, Molded Almond Color, Polypropylene

20PP-S3-04

LinkTech 20PP Series Panel Mount Female, Non-Valved, 1/4" Hose Barb, Molded Grey Color, Polypropylene

20PP-S3-04MALD

LinkTech 20PP Series Panel Mount Female, Non-Valved, 1/4" Hose Barb, Molded Almond Color, Polypropylene

20PP-S8-025MALD

LinkTech 20PP Series Panel Mount Female, Non-Valved, 5/32" PTF, Molded Almond Color, Polypropylene

20 SERIES - 1/8" FLOW SIZE: Male Open Flow Panel Mount



Reference part shown: 20AC-PB3-02

20AC-PB3-02

LinkTech 20AC Series Panel Mount Male, Non-Valved, 1/8" Hose Barb, Natural Acetal, Buna-N O-ring

20AC-PB3-03

LinkTech 20AC Series Panel Mount Male, Non-Valved, 3/16" Hose Barb, Natural Acetal, Buna-N O-ring

20CB-PB3-02

LinkTech 20CB Series Panel Mount Male, Non-Valved, 1/8" Hose Barb, Chrome Brass, Buna-N O-ring

20 SERIES - 1/8" FLOW SIZE: Female Open Flow Elbow



Reference part shown: 20AC-S4-04

20AC-S4-04

LinkTech 20AC Series Elbow Female, Non-Valved, 1/4" Hose Barb, Natural Acetal

Did You Know?

Nordson MEDICAL has an interactive PDF available online at www.nordsonmedical.com. Access part drawings, reference charts, data sheets, and more from just one location!

Need it Fast?

You can order our parts online now with no order \$ minimums, 24 hours a day, 7 days a week!
www.nordsonmedical.com

Need More Details?

Part drawings, minimum order quantities, and CAD requests can be found online. Visit www.nordsonmedical.com or contact Sales at Orders@nordsonmedical.com.

20 SERIES - 1/8" FLOW SIZE: Male Open Flow Elbow



Reference part shown: 20AC-PB4-04

20AC-PB4-02

LinkTech 20AC Series Elbow Male, Non-Valved, 1/8" Hose Barb, Natural Acetal, Buna-N O-ring

20AC-PB4-04

LinkTech 20AC Series Elbow Male, Non-Valved, 1/4" Hose Barb, Natural Acetal, Buna-N O-ring

20CB-PB4-02

LinkTech 20CB Series Elbow Male, Non-Valved, 1/8" Hose Barb, Chrome Brass, Buna-N O-ring

20CB-PB4-04

LinkTech 20CB Series Elbow Male, Non-Valved, 1/4" Hose Barb, Chrome Brass, Buna-N O-ring

20PPX-PE4-02MALD

LinkTech 20PP Series Elbow Male, Non-Valved, 1/8" Hose Barb, Molded Almond Color, Polypropylene, EPDM O-ring

20PPX-PE4-04MALD

LinkTech 20PP Series Elbow Male, Non-Valved, 1/4" Hose Barb, Molded Almond Color, Polypropylene, EPDM O-ring

20 SERIES - 1/8" FLOW SIZE: Female Valved Straight



Reference part shown: 20ACV-SB2-04

20ACV-SB1-02

LinkTech 20AC Series Male Thread Female, Valved, 1/8" MNPT, Natural Acetal, Buna-N O-ring

20ACV-SB1-02BSPT

LinkTech 20AC Series Male Thread Female, Valved, 1/8" BSPT, Natural Acetal, Buna-N O-ring

20ACV-SB1-02UT

LinkTech 20AC Series Male Thread Female, Valved, 1/8" Universal Thread, Natural Acetal, Buna-N O-ring

20ACV-SB1-04

LinkTech 20AC Series Male Thread Female, Valved, 1/4" MNPT, Natural Acetal, Buna-N O-ring

20ACV-SB1-04BSPT

LinkTech 20AC Series Male Thread Female, Valved, 1/4" BSPT, Natural Acetal, Buna-N O-ring

20 SERIES - 1/8" FLOW SIZE: Female Valved Straight

20ACV-SB2-01

LinkTech 20AC Series Straight Female, Valved, 1/16" Hose Barb, Natural Acetal, Buna-N O-ring

20ACV-SB2-02

LinkTech 20AC Series Straight Female, Valved, 1/8" Hose Barb, Natural Acetal, Buna-N O-ring

20ACV-SB2-03

LinkTech 20AC Series Straight Female, Valved, 3/16" Hose Barb, Natural Acetal, Buna-N O-ring

20ACV-SB2-04

LinkTech 20AC Series Straight Female, Valved, 1/4" Hose Barb, Natural Acetal, Buna-N O-ring

20ACV-SB9-04

LinkTech 20AC Series Straight Female, Valved, 1/4" PTF, Natural Acetal, Buna-N O-ring

20CBV-SB1-02

LinkTech 20CB Series Male Thread Female, Valved, 1/8" MNPT, Chrome Brass, Buna-N O-ring

20CBV-SB1-02BSPT

LinkTech 20CB Series Male Thread Female, Valved, 1/8" BSPT, Chrome Brass, Buna-N O-ring

20CBV-SB1-04

LinkTech 20CB Series Male Thread Female, Valved, 1/4" MNPT, Chrome Brass, Buna-N O-ring

20CBV-SB2-02

LinkTech 20CB Series Straight Female, Valved, 1/8" Hose Barb, Chrome Brass, Buna-N O-ring

20CBV-SB2-03

LinkTech 20CB Series Straight Female, Valved, 3/16" Hose Barb, Chrome Brass, Buna-N O-ring

20CBV-SB2-04

LinkTech 20CB Series Straight Female, Valved, 1/4" Hose Barb, Chrome Brass, Buna-N O-ring

20PPV-SE1-02

LinkTech 20PP Series Male Thread Female, Valved, 1/8" NPT, Molded Grey Color, Polypropylene, EPDM O-ring

20PPV-SE1-04

LinkTech 20PP Series Male Thread Female, Valved, 1/4" NPT, Molded Grey Color, Polypropylene, EPDM O-ring

20PPV-SE1-04MALD

LinkTech 20PP Series Male Thread Female, Valved, 1/4" NPT, Molded Almond Color, Polypropylene, EPDM O-ring

20PPV-SE2-01

LinkTech 20PP Series Straight Female, Valved, 1/16" Hose Barb, Molded Grey Color, Polypropylene, EPDM O-ring

20PPV-SE2-02

LinkTech 20PP Series Straight Female, Valved, 1/8" Hose Barb, Molded Grey Color, Polypropylene, EPDM O-ring

20PPV-SE2-02MALD

LinkTech 20PP Series Straight Female, Valved, 1/8" Hose Barb, Molded Almond Color, Polypropylene, EPDM O-ring

20PPV-SE2-04MALD

LinkTech 20PP Series Straight Female, Valved, 1/4" Hose Barb, Molded Almond Color, Polypropylene, EPDM O-ring

20PPV-SE9-04

LinkTech 20PP Series Straight Female, Valved, 1/4" PTF, Molded Grey Color, Polypropylene, EPDM O-ring

Reference part shown: 20ACV-PB2-04
20ACV-PB1-02

 LinkTech 20AC Series Male Thread Male, Valved, 1/8" MNPT,
 Natural Acetal, Buna-N O-ring

20ACV-PB1-02BSPT

 LinkTech 20AC Series Male Thread Male, Valved, 1/8" BSPT,
 Natural Acetal, Buna-N O-ring

20ACV-PB1-04

 LinkTech 20AC Series Male Thread Male, Valved, 1/4" MNPT,
 Natural Acetal, Buna-N O-ring

20ACV-PB1-04BSPT

 LinkTech 20AC Series Male Thread Male, Valved, 1/4" BSPT,
 Natural Acetal, Buna-N O-ring

20ACV-PB2-01

 LinkTech 20AC Series Straight Male, Valved, 1/16" Hose Barb,
 Natural Acetal, Buna-N O-ring

20ACV-PB2-02

 LinkTech 20AC Series Straight Male, Valved, 1/8" Hose Barb,
 Natural Acetal, Buna-N O-ring

20ACV-PB2-03

 LinkTech 20AC Series Straight Male, Valved, 3/16" Hose Barb,
 Natural Acetal, Buna-N O-ring

20ACV-PB2-04

 LinkTech 20AC Series Straight Male, Valved, 1/4" Hose Barb,
 Natural Acetal, Buna-N O-ring

20ACV-PB9-04

 LinkTech 20AC Series Straight Male, Valved, 1/4" PTF,
 Natural Acetal, Buna-N O-ring

20ACV-PB9-025

 LinkTech 20AC Series Straight Male, Valved, 5/32" PTF,
 Natural Acetal, Buna-N O-ring

20CBV-PB2-02

 LinkTech 20CB Series Straight Male, Valved, 1/8" Hose Barb,
 Chrome Brass, Buna-N O-ring

20CBV-PB2-04

 LinkTech 20CB Series Straight Male, Valved, 1/4" Hose Barb,
 Chrome Brass, Buna-N O-ring

20CBV-PB9-04

 LinkTech 20CB Series Straight Male, Valved, 1/4" PTF,
 Chrome Brass, Buna-N O-ring

20CBV-PB9-025

 LinkTech 20CB Series Straight Male, Valved, 5/32" PTF,
 Chrome Brass, Buna-N O-ring

20PPV-PE1-02

 LinkTech 20PP Series Male Thread Male, Valved, 1/8" NPT,
 Molded Grey Color, Polypropylene, EPDM O-ring

20PPV-PE1-02MALD

 LinkTech 20PP Series Male Thread Male, Valved, 1/8" NPT,
 Molded Almond Color, Polypropylene, EPDM O-ring

20PPV-PE2-01

 LinkTech 20PP Series Straight Male, Valved, 1/16" Hose Barb,
 Molded Grey Color, Polypropylene, EPDM O-ring

20PPV-PE2-01MALD

 LinkTech 20PP Series Straight Male, Valved, 1/16" Hose Barb,
 Molded Almond Color, Polypropylene, EPDM O-ring

20PPV-PE2-02

 LinkTech 20PP Series Straight Male, Valved, 1/8" Hose Barb,
 Molded Grey Color, Polypropylene, EPDM O-ring

20PPV-PE2-02MALD

 LinkTech 20PP Series Straight Male, Valved, 1/8" Hose Barb,
 Molded Almond Color, Polypropylene, EPDM O-ring

20PPV-PE2-04

 LinkTech 20PP Series Straight Male, Valved, 1/4" Hose Barb,
 Molded Grey Color, Polypropylene, EPDM O-ring

20PPV-PE2-04MALD

 LinkTech 20PP Series Straight Male, Valved, 1/4" Hose Barb,
 Molded Almond Color, Polypropylene, EPDM O-ring

Technical Assistance

 Trying to choose the correct part? Need more material
 information than is published in this catalog? Call Nordson
 MEDICAL Technical Support **(970) 267-5200**.

LinkTech Line Part Number Guide



Reference part shown: 20ACV-SB3-04

20ACV-SB3-01

LinkTech 20AC Series Panel Mount Female, Valved, 1/16" Hose Barb, Natural Acetal, Buna-N O-ring

20ACV-SB3-01GS

LinkTech 20AC Series Panel Mount Gasket Seal Female, Valved, 1/16" Hose Barb, Natural Acetal, Buna-N O-ring

20ACV-SB3-02

LinkTech 20AC Series Panel Mount Female, Valved, 1/8" Hose Barb, Natural Acetal, Buna-N O-ring

20ACV-SB3-02GS

LinkTech 20AC Series Panel Mount Gasket Seal Female, Valved, 1/8" Hose Barb, Natural Acetal, Buna-N O-ring

20ACV-SB3-03

LinkTech 20AC Series Panel Mount Female, Valved, 3/16" Hose Barb, Natural Acetal, Buna-N O-ring

20ACV-SB3-03GS

LinkTech 20AC Series Panel Mount Gasket Seal Female, Valved, 3/16" Hose Barb, Natural Acetal, Buna-N O-ring

20ACV-SB3-04

LinkTech 20AC Series Panel Mount Female, Valved, 1/4" Hose Barb, Natural Acetal, Buna-N O-ring

20ACV-SB3-04GS

LinkTech 20AC Series Panel Mount Gasket Seal Female, Valved, 1/4" Hose Barb, Natural Acetal, Buna-N O-ring

20ACV-SB8-04

LinkTech 20AC Series Panel Mount Female, Valved, 1/4" PTF, Natural Acetal, Buna-N O-ring

20ACV-SB8-04GS

LinkTech 20AC Series Panel Mount Gasket Seal Female, Valved, 1/4" PTF, Natural Acetal, Buna-N O-ring

20ACV-SB8-025

LinkTech 20AC Series Panel Mount Female, Valved, 5/32" PTF, Natural Acetal, Buna-N O-ring

20CBV-SB3-02

LinkTech 20CB Series Panel Mount Female, Valved, 1/8" Hose Barb, Chrome Brass, Buna-N O-ring

20CBV-SB8-04

LinkTech 20CB Series Panel Mount Female, Valved, 1/4" PTF, Chrome Brass, Buna-N O-ring

20CBV-SB19-1032

LinkTech 20CB Series Panel Mount Female, Female Thread, Valved, 10/32", Chrome Brass, Buna-N O-ring

20PPV-SE3-01

LinkTech 20PP Series Panel Mount Female, Valved, 1/16" Hose Barb, Molded Grey Color, Polypropylene, EPDM O-ring

20PPV-SE3-02

LinkTech 20PP Series Panel Mount Female, Valved, 1/8" Hose Barb, Molded Grey Color, Polypropylene, EPDM O-ring

20PPV-SE3-02MALD

LinkTech 20PP Series Panel Mount Female, Valved, 1/8" Hose Barb, Molded Almond Color, Polypropylene, EPDM O-ring

20PPV-SE3-04

LinkTech 20PP Series Panel Mount Female, Valved, 1/4" Hose Barb, Molded Grey Color, Polypropylene, EPDM O-ring

20PPV-SE3-04GSPNMALD

LinkTech 20PP Series Panel Mount Female, Valved, 1/4" Hose Barb, Molded Almond Color, Polypropylene, EPDM O-ring

20PPV-SE3-04MALD

LinkTech 20PP Series Panel Mount Female, Valved, 1/4" Hose Barb, Molded Almond Color, Polypropylene, EPDM O-ring

20PPV-SE8-04

LinkTech 20PP Series Panel Mount Female, Valved, 1/4" PTF, Molded Grey Color, Polypropylene, EPDM O-ring

20PPV-SE19-04GSPNMALD

LinkTech 20PP Series Panel Mount Female, Valved, 1/4-28" Flat Bottom Port, Molded Almond Color, Polypropylene, EPDM O-ring

Part Drawings Online!

Nordson MEDICAL provides dimensional drawings available for download for all of its fittings. www.nordsonmedical.com

Custom Assembly

We produce standard components to fit your current assemblies and devices, but we also provide custom solutions by applying a variety of assembly options, such as joining fittings, connectors, filters, and other components to tubing. From systems using a single fitting to complex configurations utilizing various components, we can design complete assemblies to your requirements.

20 SERIES - 1/8" FLOW SIZE: Male Valved Panel Mount



Reference part shown: 20ACV-PB3-04

20ACV-PB3-01

LinkTech 20AC Series Panel Mount Male, Valved, 1/16" Hose Barb, Natural Acetal, Buna-N O-ring

20ACV-PB3-02

LinkTech 20AC Series Panel Mount Male, Valved, 1/8" Hose Barb, Natural Acetal, Buna-N O-ring

20ACV-PB3-03

LinkTech 20AC Series Panel Mount Male, Valved, 3/16" Hose Barb, Natural Acetal, Buna-N O-ring

20ACV-PB3-04

LinkTech 20AC Series Panel Mount Male, Valved, 1/4" Hose Barb, Natural Acetal, Buna-N O-ring

20ACV-PB8-04

LinkTech 20AC Series Panel Mount Male, Valved, 1/4" PTF, Natural Acetal, Buna-N O-ring

20CBV-PB3-02

LinkTech 20CB Series Panel Mount Male, Valved, 1/8" Hose Barb, Chrome Brass, Buna-N O-ring

20CBV-PB3-03

LinkTech 20CB Series Panel Mount Male, Valved, 3/16" Hose Barb, Chrome Brass, Buna-N O-ring

20CBV-PB3-04

LinkTech 20CB Series Panel Mount Male, Valved, 1/4" Hose Barb, Chrome Brass, Buna-N O-ring

20CBV-PB8-04

LinkTech 20CB Series Panel Mount Male, Valved, 1/4" PTF, Chrome Brass, Buna-N O-ring

20PPV-PE19-04GSPNMALD

LinkTech 20PP Series Panel Mount Male, Valved, 1/4-28" Flat Bottom Port, Molded Almond Color, Polypropylene, EPDM O-ring

QUICK
CONNECTS

20 SERIES - 1/8" FLOW SIZE: Female Valved Elbow



Reference part shown: 20ACV-SB4-04

20ACV-SB4-02

LinkTech 20AC Series Elbow Female, Valved, 1/8" Hose Barb, Natural Acetal, Buna-N O-ring

20ACV-SB4-04

LinkTech 20AC Series Elbow Female, Valved, 1/4" Hose Barb, Natural Acetal, Buna-N O-ring

20ACV-SB10-04

LinkTech 20AC Series Elbow Female, Valved, 1/4" PTF, Natural Acetal, Buna-N O-ring

20 SERIES - 1/8" FLOW SIZE: Male Valved Elbow



Reference part shown: 20ACV-PB4-04

20ACV-PB4-02

LinkTech 20AC Series Elbow Male, Valved, 1/8" Hose Barb, Natural Acetal, Buna-N O-ring

20ACV-PB4-04

LinkTech 20AC Series Elbow Male, Valved, 1/4" Hose Barb, Natural Acetal, Buna-N O-ring

20CBV-PB10-04

LinkTech 20CB Series Elbow Male, Valved, 1/4" PTF, Chrome Brass, Buna-N O-ring

20PPV-PE4-02

LinkTech 20PP Series Elbow Male, Valved, 1/8" Hose Barb, Molded Grey Color, Polypropylene, EPDM O-ring

20PPV-PE4-02MALD

LinkTech 20PP Series Elbow Male, Valved, 1/8" Hose Barb, Molded Almond Color, Polypropylene, EPDM O-ring

20PPV-PE4-04

LinkTech 20PP Series Elbow Male, Valved, 1/4" Hose Barb, Molded Grey Color, Polypropylene, EPDM O-ring

20PPV-PE4-04MALD

LinkTech 20PP Series Elbow Male, Valved, 1/4" Hose Barb, Molded Almond Color, Polypropylene, EPDM O-ring

20PPV-PE10-04

LinkTech 20PP Series Elbow Male, Valved, 1/4" PTF, Molded Grey Color, Polypropylene, EPDM O-ring

Need Samples for Evaluation?

You can call to request most of our standard product in quantities of 5, or less, for free application evaluation.

+1 (970) 267-5200 Toll Free: (888) 404-5837

30Series

Quick Connect Couplings

30 SERIES - 1/8" FLOW SIZE: Female Open Flow Straight



Reference part shown: 30AC-S2-04

30AC-S2-02

LinkTech 30AC Series Straight Female, Non-Valved, 1/8" Hose Barb, Natural Acetal

30AC-S2-04

LinkTech 30AC Series Straight Female, Non-Valved, 1/4" Hose Barb, Natural Acetal

30 SERIES - 1/8" FLOW SIZE: Male Open Flow Straight



Reference part shown: 30ACX-PB1-04

30ACX-PB1-04

LinkTech 30AC Series Male Thread Male, Non-Valved, 1/4" MNPT, Natural Acetal, Buna-N O-ring

30 SERIES - 1/8" FLOW SIZE: Female Valved Straight



Reference part shown: 30ACV-SB2-04

30ACV-SB2-02

LinkTech 30AC Series Straight Female, Valved, 1/8" Hose Barb, Natural Acetal, Buna-N O-ring

30ACV-SB2-04

LinkTech 30AC Series Straight Female, Valved, 1/4" Hose Barb, Natural Acetal, Buna-N O-ring

30ACV-SB9-04

LinkTech 30AC Series Straight Female, Valved, 1/4" PTF, Natural Acetal, Buna-N O-ring



Reference part shown: 30ACV-PB2-02

30ACV-PB2-02

LinkTech 30AC Series Straight Male, Valved, 1/8" Hose Barb, Natural Acetal, Buna-N O-ring

30ACV-PB2-04

LinkTech 30AC Series Straight Male, Valved, 1/4" Hose Barb, Natural Acetal, Buna-N O-ring

30 SERIES - 1/8" FLOW SIZE: Male Valved Elbow



Reference part shown: 30ACV-PB10-04

30ACV-PB10-04

LinkTech 30AC Series Elbow Male, Valved, 1/4" PTF, Natural Acetal, Buna-N O-ring

33Series

Quick Connect Couplings

33 SERIES - 1/8" FLOW SIZE: Female Valved Straight



Reference part shown: 33PCV-SPS2-02

33PCV-SPS2-02

LinkTech 33PC Series Straight Female, Valved, Duckbill, 1/8" Hose Barb, Polycarbonate

QUICK CONNECTS

40Series

Quick Connect Couplings

40 SERIES - 1/4" FLOW SIZE: Female Open Flow Straight



Reference part shown: 40AC-S2-04

40AC-S1-04

LinkTech 40AC Series Male Thread Female, Non-Valved, 1/4" MNPT, Natural Acetal

40AC-S1-04BSPT

LinkTech 40AC Series Male Thread Female, Non-Valved, 1/4" BSPT, Natural Acetal

40AC-S1-06

LinkTech 40AC Series Male Thread Female, Non-Valved, 3/8" MNPT, Natural Acetal

40AC-S1-06BLK

LinkTech 40AC Series Male Thread Female, Non-Valved, 3/8" BSPT, Natural Acetal

40AC-S2-04

LinkTech 40AC Series Straight Female, Non-Valved, 1/4" Hose Barb, Natural Acetal

40AC-S2-05

LinkTech 40AC Series Straight Female, Non-Valved, 5/16" Hose Barb, Natural Acetal

40AC-S2-06

LinkTech 40AC Series Straight Female, Non-Valved, 3/8" Hose Barb, Natural Acetal

40AC-S9-04

LinkTech 40AC Series Straight Female, Non-Valved, 1/4" PTF, Natural Acetal

40CB-S1-04

LinkTech 40CB Series Male Thread Female, Non-Valved, 1/4" MNPT, Chrome Brass

40CB-S1-04BSPT

LinkTech 40CB Series Male Thread Female, Non-Valved, 1/4" BSPT, Chrome Brass

40 SERIES - 1/4" FLOW SIZE: Female Open Flow Straight

40CB-S2-04

LinkTech 40CB Series Straight Female, Non-Valved, 1/4" Hose Barb, Chrome Brass

40PP-S1-04

LinkTech 40PP Series Male Thread Female, Non-Valved, 1/4" NPT, Molded Grey Color, Polypropylene

40PP-S2-04

LinkTech 40PP Series Straight Female, Non-Valved, 1/4" Hose Barb, Molded Grey Color, Polypropylene

40PP-S9-06

LinkTech 40PP Series Straight Female, Non-Valved, 3/8" PTF, Molded Grey Color, Polypropylene

40 SERIES - 1/4" FLOW SIZE: Male Open Flow Straight



Reference part shown: 40AC-PB2-04

40AC-PB1-04

LinkTech 40AC Series Male Thread Male, Non-Valved, 1/4" MNPT, Natural Acetal, Buna-N O-ring

40AC-PB2-04

LinkTech 40AC Series Straight Male, Non-Valved, 1/4" Hose Barb, Natural Acetal, Buna-N O-ring

40AC-PB2-05

LinkTech 40AC Series Straight Male, Non-Valved, 5/16" Hose Barb, Natural Acetal, Buna-N O-ring

40AC-PB2-06

LinkTech 40AC Series Straight Male, Non-Valved, 3/8" Hose Barb, Natural Acetal, Buna-N O-ring

40CB-PB1-04

LinkTech 40CB Series Male Thread Male, Non-Valved, 1/4" MNPT, Chrome Brass, Buna-N O-ring

40CB-PB2-06

LinkTech 40CB Series Straight Male, Non-Valved, 3/8" Hose Barb, Chrome Brass, Buna-N O-ring

40PP-PE2-04

LinkTech 40PP Series Straight Male, Non-Valved, 1/4" Hose Barb, Molded Grey Color, Polypropylene, EPDM O-ring



Reference part shown: 40AC-S3-06

40AC-S3-04

LinkTech 40AC Series Panel Mount Female, Non-Valved, 1/4" Hose Barb, Natural Acetal

40AC-S3-06

LinkTech 40AC Series Panel Mount Female, Non-Valved, 3/8" Hose Barb, Natural Acetal

40AC-S8-04

LinkTech 40AC Series Panel Mount Female, Non-Valved, 1/4" PTF, Natural Acetal

40CB-S8-04

LinkTech 40CB Series Panel Mount Female, Non-Valved, 1/4" PTF, Chrome Brass

40CB-S12-04

LinkTech 40CB Series Panel Mount Female, Male Thread, Non-Valved, 1/4" MNPT, Chrome Brass

40PP-S3-04

LinkTech 40PP Series Panel Mount Female, Non-Valved, 1/4" Hose Barb, Molded Grey Color, Polypropylene

40PP-S3-04MALD

LinkTech 40PP Series Panel Mount Female, Non-Valved, 1/4" Hose Barb, Molded Almond Color, Polypropylene

40PP-S8-06

LinkTech 40PP Series Panel Mount Female, Non-Valved, 3/8" PTF, Molded Grey Color, Polypropylene

40 SERIES - 1/4" FLOW SIZE:
Male Open Flow Panel Mount



Reference part shown: 40AC-PB3-04

40AC-PB3-04

LinkTech 40AC Series Panel Mount Male, Non-Valved, 1/4" Hose Barb, Natural Acetal, Buna-N O-ring

40AC-PB3-06

LinkTech 40AC Series Panel Mount Male, Non-Valved, 3/8" Hose Barb, Natural Acetal, Buna-N O-ring

40AC-PB8-06

LinkTech 40AC Series Panel Mount Male, Non-Valved, 3/8" PTF, Natural Acetal, Buna-N O-ring



Reference part shown: 40AC-PB4-06

40AC-PB4-04

LinkTech 40AC Series Elbow Male, Non-Valved, 1/4" Hose Barb, Natural Acetal, Buna-N O-ring

40AC-PB4-06

LinkTech 40AC Series Elbow Male, Non-Valved, 3/8" Hose Barb, Natural Acetal, Buna-N O-ring

40CB-PB10-04

LinkTech 40CB Series Elbow Male, Non-Valved, 1/4" PTF, Chrome Brass, Buna-N O-ring

QUICK
CONNECTS

Looking for Something Different?

Most of our best product ideas have come from you, our customers. While we pride ourselves on our extensive product offering, we recognize that your needs are ever-changing and that our products, too, must adapt to your needs.

If there's a new product you think Nordson MEDICAL should make, please send us an Email at Orders@nordsonmedical.com describing your product concept in as much detail as you desire. We will contact you with any questions, and who knows - the next catalog edition could include products YOU told us to build.

See page 8-9 for more information on custom engineered solutions!



40 SERIES - 1/4" FLOW SIZE: Female Valved Straight



Reference part shown: 40ACV-SB2-04

40ACV-SB1-04

LinkTech 40AC Series Male Thread Female, Valved, 1/4" MNPT, Natural Acetal, Buna-N O-ring

40ACV-SB1-04BSPT

LinkTech 40AC Series Male Thread Female, Valved, 1/4" BSPT, Natural Acetal, Buna-N O-ring

40ACV-SB1-06

LinkTech 40AC Series Male Thread Female, Valved, 3/8" MNPT, Natural Acetal, Buna-N O-ring

40ACV-SB1-06BSPT

LinkTech 40AC Series Male Thread Female, Valved, 3/8" BSPT, Natural Acetal, Buna-N O-ring

40ACV-SB2-04

LinkTech 40AC Series Straight Female, Valved, 1/4" Hose Barb, Natural Acetal, Buna-N O-ring

40ACV-SB2-05

LinkTech 40AC Series Straight Female, Valved, 5/16" Hose Barb, Natural Acetal, Buna-N O-ring

40ACV-SB2-06

LinkTech 40AC Series Straight Female, Valved, 3/8" Hose Barb, Natural Acetal, Buna-N O-ring

40ACV-SB9-04

LinkTech 40AC Series Straight Female, Valved, 1/4" PTF, Natural Acetal, Buna-N O-ring

40ACV-SB9-06

LinkTech 40AC Series Straight Female, Valved, 3/8" PTF, Natural Acetal, Buna-N O-ring

40CBV-SB1-04

LinkTech 40CB Series Male Thread Female, Valved, 1/4" MNPT, Chrome Brass, Buna-N O-ring

40CBV-SB1-04BSPT

LinkTech 40CB Series Male Thread Female, Valved, 1/4" BSPT, Chrome Brass, Buna-N O-ring

40CBV-SB1-06

LinkTech 40CB Series Male Thread Female, Valved, 3/8" MNPT, Chrome Brass, Buna-N O-ring

40CBV-SB1-06BSPT

LinkTech 40CB Series Male Thread Female, Valved, 3/8" BSPT, Chrome Brass, Buna-N O-ring

40CBV-SB2-04

LinkTech 40CB Series Straight Female, Valved, 1/4" Hose Barb, Chrome Brass, Buna-N O-ring

40CBV-SB2-06

LinkTech 40CB Series Straight Female, Valved, 3/8" Hose Barb, Chrome Brass, Buna-N O-ring

40CBV-SB9-06

LinkTech 40CB Series Straight Female, Valved, 3/8" PTF, Chrome Brass, Buna-N O-ring

40PPV-SE1-04

LinkTech 40PP Series Male Thread Female, Valved, 1/4" NPT, Molded Grey Color, Polypropylene, EPDM O-ring

40PPV-SE2-04

LinkTech 40PP Series Straight Female, Valved, 1/4" Hose Barb, Molded Grey Color, Polypropylene, EPDM O-ring

40PPV-SE2-06MALD

LinkTech 40PP Series Straight Female, Valved, 3/8" Hose Barb, Molded Almond Color, Polypropylene, EPDM O-ring

40PPV-SE9-06

LinkTech 40PP Series Straight Female, Valved, 3/8" PTF, Molded Grey Color, Polypropylene, EPDM O-ring

40 SERIES - 1/4" FLOW SIZE: Male Valved Straight



Reference part shown: 40ACV-PB2-04

40ACV-PB2-04

LinkTech 40AC Series Straight Male, Valved, 1/4" Hose Barb, Natural Acetal, Buna-N O-ring

40ACV-PB2-05

LinkTech 40AC Series Straight Male, Valved, 5/16" Hose Barb, Natural Acetal, Buna-N O-ring

40ACV-PB2-06

LinkTech 40AC Series Straight Male, Valved, 3/8" Hose Barb, Natural Acetal, Buna-N O-ring

40ACV-PB9-04

LinkTech 40AC Series Straight Male, Valved, 1/4" PTF, Natural Acetal, Buna-N O-ring

40ACV-PB9-06

LinkTech 40AC Series Straight Male, Valved, 3/8" PTF, Natural Acetal, Buna-N O-ring

40 SERIES - 1/4" FLOW SIZE: Male Valved Straight

40ACV-PB17-04

LinkTech 40AC Series Straight Male, Valved, 1/4" OD Push-In, Natural Acetal, Buna-N O-ring

40CBV-PB1-04

LinkTech 40CB Series Male Thread Male, Valved, 1/4" MNPT, Chrome Brass, Buna-N O-ring

40CBV-PB1-04BSPT

LinkTech 40CB Series Male Thread Male, Valved, 1/4" BSPT, Chrome Brass, Buna-N O-ring

40CBV-PB2-04

LinkTech 40CB Series Straight Male, Valved, 1/4" Hose Barb, Chrome Brass, Buna-N O-ring

40CBV-PB2-05

LinkTech 40CB Series Straight Male, Valved, 5/16" Hose Barb, Chrome Brass, Buna-N O-ring

40CBV-PB2-06

LinkTech 40CB Series Straight Male, Valved, 3/8" Hose Barb, Chrome Brass, Buna-N O-ring

40CBV-PB9-04

LinkTech 40CB Series Straight Male, Valved, 1/4" PTF, Chrome Brass, Buna-N O-ring

40CBV-PB9-06

LinkTech 40CB Series Straight Male, Valved, 3/8" PTF, Chrome Brass, Buna-N O-ring

40PPV-PE2-04

LinkTech 40PP Series Straight Male, Valved, 1/4" Hose Barb, Molded Grey Color, Polypropylene, EPDM O-ring

40PPV-PE2-04MALD

LinkTech 40PP Series Straight Male, Valved, 1/4" Hose Barb, Molded Almond Color, Polypropylene, EPDM O-ring

40PPV-PE2-06

LinkTech 40PP Series Straight Male, Valved, 3/8" Hose Barb, Molded Grey Color, Polypropylene, EPDM O-ring

40PPV-PE2-06MALD

LinkTech 40PP Series Straight Male, Valved, 3/8" Hose Barb, Molded Almond Color, Polypropylene, EPDM O-ring

Need it Fast?

You can order our parts online now with no order \$ minimums, 24 hours a day, 7 days a week!

www.nordsonmedical.com

40 SERIES - 1/4" FLOW SIZE: Female Valved Panel Mount



Reference part shown: 40ACV-SB3-06

40ACV-SB3-04

LinkTech 40AC Series Panel Mount Female, Valved, 1/4" Hose Barb, Natural Acetal, Buna-N O-ring

40ACV-SB3-05

LinkTech 40AC Series Panel Mount Female, Valved, 5/16" Hose Barb, Natural Acetal, Buna-N O-ring

40ACV-SB3-06

LinkTech 40AC Series Panel Mount Female, Valved, 3/8" Hose Barb, Natural Acetal, Buna-N O-ring

40ACV-SB8-04

LinkTech 40AC Series Panel Mount Female, Valved, 1/4" PTF, Natural Acetal, Buna-N O-ring

40ACV-SB8-06

LinkTech 40AC Series Panel Mount Female, Valved, 3/8" PTF, Natural Acetal, Buna-N O-ring

40ACV-SB18-04

LinkTech 40AC Series Panel Mount Female, Valved, 1/4" OD Push-In, Natural Acetal, Buna-N O-ring

40CBV-SB3-04

LinkTech 40CB Series Panel Mount Female, Valved, 1/4" Hose Barb, Chrome Brass, Buna-N O-ring

40CBV-SB3-06

LinkTech 40CB Series Panel Mount Female, Valved, 3/8" Hose Barb, Chrome Brass, Buna-N O-ring

40CBV-SB8-04

LinkTech 40CB Series Panel Mount Female, Valved, 1/4" PTF, Chrome Brass, Buna-N O-ring

40CBV-SB12-04

LinkTech 40CB Series Panel Mount Female, Male Thread, Valved, 1/4" MNPT, Chrome Brass, Buna-N O-ring

40PPV-SE3-04

LinkTech 40PP Series Panel Mount Female, Valved, 1/4" Hose Barb, Molded Grey Color, Polypropylene, EPDM O-ring

40PPV-SE3-04MALD

LinkTech 40PP Series Panel Mount Female, Valved, 1/4" Hose Barb, Molded Almond Color, Polypropylene, EPDM O-ring

40PPV-SE3-06

LinkTech 40PP Series Panel Mount Female, Valved, 3/8" Hose Barb, Molded Grey Color, Polypropylene, EPDM O-ring

40PPV-SE3-06MALD

LinkTech 40PP Series Panel Mount Female, Valved, 3/8" Hose Barb, Molded Almond Color, Polypropylene, EPDM O-ring

40PPV-SE8-06MALD

LinkTech 40PP Series Panel Mount Female, Valved, 3/8" PTF, Molded Almond Color, Polypropylene, EPDM O-ring

40 SERIES - 1/4" FLOW SIZE: Male Valved Panel Mount



Reference part shown: 40ACV-PB3-04

40ACV-PB3-04

LinkTech 40AC Series Panel Mount Male, Valved, 1/4" Hose Barb, Natural Acetal, Buna-N O-ring

40ACV-PB3-05

LinkTech 40AC Series Panel Mount Male, Valved, 5/16" Hose Barb, Natural Acetal, Buna-N O-ring

40ACV-PB8-04

LinkTech 40AC Series Panel Mount Male, Valved, 1/4" PTF, Natural Acetal, Buna-N O-ring

40ACV-PB18-04

LinkTech 40AC Series Panel Mount Male, Valved, 1/4" OD Push-In, Natural Acetal, Buna-N O-ring

40CBV-PB3-04

LinkTech 40CB Series Panel Mount Male, Valved, 1/4" Hose Barb, Chrome Brass, Buna-N O-ring

40CBV-PB3-06

LinkTech 40CB Series Panel Mount Male, Valved, 3/8" Hose Barb, Chrome Brass, Buna-N O-ring

40PPV-PE3-04

LinkTech 40PP Series Panel Mount Male, Valved, 1/4" Hose Barb, Molded Grey Color, Polypropylene, EPDM O-ring

QUICK
CONNECTS

40 SERIES - 1/4" FLOW SIZE: Male Valved Elbow



Reference part shown: 40ACV-PB4-06

40ACV-PB4-04

LinkTech 40AC Series Elbow Male, Valved, 1/4" Hose Barb, Natural Acetal, Buna-N O-ring

40ACV-PB4-06

LinkTech 40AC Series Elbow Male, Valved, 3/8" Hose Barb, Natural Acetal, Buna-N O-ring

40ACV-PB10-06

LinkTech 40AC Series Elbow Male, Valved, 3/8" PTF, Natural Acetal, Buna-N O-ring

40CBV-PB4-04

LinkTech 40CB Series Elbow Male, Valved, 1/4" Hose Barb, Chrome Brass, Buna-N O-ring

40 SERIES - 1/4" FLOW SIZE: Male Valved Elbow

40CBV-PB4-06

LinkTech 40CB Series Elbow Male, Valved, 3/8" Hose Barb, Chrome Brass, Buna-N O-ring

40CBV-PB10-04

LinkTech 40CB Series Elbow Male, Valved, 1/4" PTF, Chrome Brass, Buna-N O-ring

40CBV-PB10-06

LinkTech 40CB Series Elbow Male, Valved, 3/8" PTF, Chrome Brass, Buna-N O-ring

40PPV-PE4-04

LinkTech 40PP Series Elbow Male, Valved, 1/4" Hose Barb, Molded Grey Color, Polypropylene, EPDM O-ring

40PPV-PE4-04MALD

LinkTech 40PP Series Elbow Male, Valved, 1/4" Hose Barb, Molded Almond Color, Polypropylene, EPDM O-ring

40PPV-PE4-06

LinkTech 40PP Series Elbow Male, Valved, 3/8" Hose Barb, Molded Grey Color, Polypropylene, EPDM O-ring

40PPV-PE10-06MALD

LinkTech 40PP Series Elbow Male, Valved, 3/8" PTF, Molded Almond Color, Polypropylene, EPDM O-ring

42Series

Quick Connect Couplings

42 SERIES - 3/32" FLOW SIZE: Male Open Flow Straight



Reference part shown: 42AB-PB2-02

42AB-PB2-02

LinkTech 42AB Series Straight Male, Non-Valved, 1/8" Hose Barb, ABS, Buna-N O-ring

42 SERIES - 3/32" FLOW SIZE: Female Open Flow Panel Mount



Reference part shown: 42AB-S3-02

42AB-S3-02

LinkTech 42AB Series Panel Mount Female, Non-Valved, 1/8" Hose Barb, ABS

50Series

Quick Connect Couplings



50 SERIES - 1/4" FLOW SIZE: Female Open Flow Straight



Reference part shown: 50AC-S2-06LB

50AC-S1-04

LinkTech 50AC Series Male Thread Female, Non-Valved, 1/4" MNPT, Natural Acetal

50AC-S1-06

LinkTech 50AC Series Male Thread Female, Non-Valved, 3/8" MNPT, Natural Acetal

50AC-S2-04

LinkTech 50AC Series Straight Female, Non-Valved, 1/4" Hose Barb, Natural Acetal

50AC-S2-06

LinkTech 50AC Series Straight Female, Non-Valved, 3/8" Hose Barb, Natural Acetal

50AC-S2-06LB

LinkTech 50AC Series Straight Female, Non-Valved, 3/8" Hose Barb, Long Body, Natural Acetal

50BAC-S1-04

LinkTech 50BAC Series Male Thread Female, Non-Valved, 1/4" MNPT, Natural Acetal

50BAC-S2-05LB

LinkTech 50BAC Series Straight Female, Non-Valved, 5/16" Hose Barb, Long Body, Natural Acetal

50BAC-S2-06LB

LinkTech 50BAC Series Straight Female, Non-Valved, 3/8" Hose Barb, Long Body, Natural Acetal

50BAC-S9-06LB

LinkTech 50BAC Series Straight Female, Non-Valved, 3/8" PTF, Long Body, Natural Acetal

50GP-S1-04

LinkTech 50GP Series Male Thread Female, Non-Valved, 1/4" MNPT, Glass-Filled Polypropylene

50GP-S5-04

LinkTech 50GP Series Straight Female, Non-Valved, 1/4" Hose Barb, Glass-Filled Polypropylene

50GP-S5-06

LinkTech 50GP Series Straight Female, Non-Valved, 3/8" Hose Barb, Glass-Filled Polypropylene

Reference part shown: 50AC-PB2-06

50AC-PB2-04

LinkTech 50AC Series Straight Male, Non-Valved, 1/4" Hose Barb, Natural Acetal, Buna-N O-ring

50AC-PB2-06

LinkTech 50AC Series Straight Male, Non-Valved, 3/8" Hose Barb, Natural Acetal, Buna-N O-ring

50AC-PB9-04

LinkTech 50AC Series Straight Male, Non-Valved, 1/4" PTF, Natural Acetal, Buna-N O-ring

50AC-PB17-04

LinkTech 50AC Series Straight Male, Non-Valved, 1/4" OD Push-In, Natural Acetal, Buna-N O-ring

50GP-PF5-04

LinkTech 50GP Series Straight Male, Non-Valved, 1/4" Hose Barb, Glass-Filled Polypropylene, Food Grade EPDM O-ring

50GP-PF5-06

LinkTech 50GP Series Straight Male, Non-Valved, 3/8" Hose Barb, Glass-Filled Polypropylene, Food Grade EPDM O-ring

50GP-PF6

LinkTech 50GP Series End Stop Male, Glass-Filled Polypropylene, Food Grade EPDM O-ring

50PPX-PE1-04

LinkTech 50PP Series Male Thread Male, Non-Valved, 1/4" MNPT, Polypropylene, EPDM O-ring

50PPX-PE1-06

LinkTech 50PP Series Male Thread Male, Non-Valved, 3/8" MNPT, Polypropylene, EPDM O-ring

QUICK
CONNECTS

Did You Know?

Nordson MEDICAL has an interactive PDF available online at www.nordsonmedical.com. Access part drawings, reference charts, data sheets, and more from just one location!

Need More Details?

Part drawings, minimum order quantities, and CAD requests can be found online. Visit www.nordsonmedical.com or contact Sales at Orders@nordsonmedical.com.

50 SERIES - 1/4" FLOW SIZE: Female Open Flow Panel Mount



Reference part shown: 50AC-S3-04

50AC-S3-04

LinkTech 50AC Series Panel Mount Female, Non-Valved, 1/4" Hose Barb, Natural Acetal

50AC-S3-06

LinkTech 50AC Series Panel Mount Female, Non-Valved, 3/8" Hose Barb, Natural Acetal

50AC-S8-06

LinkTech 50AC Series Panel Mount Female, Non-Valved, 3/8" PTF, Natural Acetal

50BAC-S8-04

LinkTech 50BAC Series Panel Mount Female, Non-Valved, 1/4" PTF, Natural Acetal

50BAC-S8-06

LinkTech 50BAC Series Panel Mount Female, Non-Valved, 3/8" PTF, Natural Acetal

QUICK
CONNECTS

50 SERIES - 1/4" FLOW SIZE: Female Open Flow Elbow



Reference part shown: 50GP-S7-06

50GP-S7-06

LinkTech 50GP Series Elbow Female, Non-Valved, 3/8" Hose Barb, Glass-Filled Polypropylene

50 SERIES - 1/4" FLOW SIZE: Male Open Flow Elbow



Reference part shown: 50AC-PB4-06

50AC-PB4-06

LinkTech 50AC Series Elbow Male, Non-Valved, 3/8" Hose Barb, Natural Acetal, Buna-N O-ring

50GP-PF7-06

LinkTech 50GP Series Elbow Male, Non-Valved, 3/8" Hose Barb, Glass-Filled Polypropylene, Food Grade EPDM O-ring

50 SERIES - 1/4" FLOW SIZE: Female Valved Straight



Reference part shown: 50ACV-SB2-06

50ACV-SB1-06

LinkTech 50AC Series Male Thread Female, Valved, 3/8" MNPT, Natural Acetal, Buna-N O-ring

50ACV-SB2-04

LinkTech 50AC Series Straight Female, Valved, 1/4" Hose Barb, Natural Acetal, Buna-N O-ring

50ACV-SB2-06

LinkTech 50AC Series Straight Female, Valved, 3/8" Hose Barb, Natural Acetal, Buna-N O-ring

50GPV-SF5-06

LinkTech 50GP Series Straight Female, Valved, 3/8" Hose Barb, Glass-Filled Polypropylene, Food Grade EPDM O-ring

Custom Assembly

We produce standard components to fit your current assemblies and devices, but we also provide custom solutions by applying a variety of assembly options, such as joining fittings, connectors, filters, and other components to tubing. From systems using a single fitting to complex configurations utilizing various components, we can design complete assemblies to your requirements.



Reference part shown: 50ACV-PB2-06

50ACV-PB1-04

LinkTech 50AC Series Male Thread Male, Valved, 1/4" MNPT, Natural Acetal, Buna-N O-ring

50ACV-PB2-04

LinkTech 50AC Series Straight Male, Valved, 1/4" Hose Barb, Natural Acetal, Buna-N O-ring

50ACV-PB2-06

LinkTech 50AC Series Straight Male, Valved, 3/8" Hose Barb, Natural Acetal, Buna-N O-ring

50PPV-PE2-06

LinkTech 50PP Series Straight Male, Valved, 3/8" Hose Barb, Polypropylene, EPDM O-ring



Reference part shown: 50ACV-PB4-06

50ACV-PB4-04

LinkTech 50AC Series Elbow Male, Valved, 1/4" Hose Barb, Natural Acetal, Buna-N O-ring

50ACV-PB4-06

LinkTech 50AC Series Elbow Male, Valved, 3/8" Hose Barb, Natural Acetal, Buna-N O-ring

50PPV-PE4-04

LinkTech 50PP Series Elbow Male, Valved, 1/4" Hose Barb, Polypropylene, EPDM O-ring

50PPV-PE4-06

LinkTech 50PP Series Elbow Male, Valved, 3/8" Hose Barb, Polypropylene, EPDM O-ring



Reference part shown: 50ACV-SB3-06

50ACV-SB3-04

LinkTech 50AC Series Panel Mount Female, Valved, 1/4" Hose Barb, Natural Acetal, Buna-N O-ring

50ACV-SB3-06

LinkTech 50AC Series Panel Mount Female, Valved, 3/8" Hose Barb, Natural Acetal, Buna-N O-ring

50BACV-SB3-05

LinkTech 50BAC Series Panel Mount Female, Valved, 5/16" Hose Barb, Natural Acetal, Buna-N O-ring

50PPV-SE3-04

LinkTech 50PP Series Panel Mount Female, Valved, 1/4" Hose Barb, Polypropylene, EPDM O-ring

50PPV-SE3-06

LinkTech 50PP Series Panel Mount Female, Valved, 3/8" Hose Barb, Polypropylene, EPDM O-ring

Need Samples for Evaluation?

You can call to request most of our standard product in quantities of 5, or less, for free application evaluation.

+1 (970) 267-5200 Toll Free: (888) 404-5837

Technical Assistance

Trying to choose the correct part? Need more material information than is published in this catalog? Call Nordson MEDICAL Technical Support **(970) 267-5200**.

55Series

Quick Connect Couplings

55 SERIES - 1/8" - 1/4" FLOW SIZE:
Female Valved Straight



Reference part shown: 55GPV-SE2-06

55GPV-SE2-06

LinkTech 55GP Series Straight Female, Valved, 3/8" Hose Barb, Glass-Filled Polypropylene, EPDM O-ring

55 SERIES - 1/8" - 1/4" FLOW SIZE:
Male Valved Straight



Reference part shown: 55GPV-PE2-06

55GPV-PE2-06

LinkTech 55GP Series Straight Male, Valved, 3/8" Hose Barb, Glass-Filled Polypropylene, EPDM O-ring

60Series

Quick Connect Couplings

60 SERIES - 3/8" FLOW SIZE:
Female Open Flow Straight



Reference part shown: 60PP-S2-08

60PP-S1-12

LinkTech 60PP Series Male Thread Female, Non-Valved, 3/4" MNPT, Polypropylene

60PP-S2-08

LinkTech 60PP Series Straight Female, Non-Valved, 1/2" Hose Barb, Polypropylene

60PP-S2-06

LinkTech 60PS Series Straight Female, Non-Valved, 3/8" Hose Barb, Polysulfone

60PS-S2-08

LinkTech 60PS Series Straight Female, Non-Valved, 1/2" Hose Barb, Polysulfone

60PS-S2-08BLK

LinkTech 60PS Series Straight Female, Non-Valved, 1/2" Hose Barb, Molded Black Color, Polysulfone

QUICK
CONNECTS

Need it Fast?

You can order our parts online now with no order \$ minimums, 24 hours a day, 7 days a week!
www.nordsonmedical.com

Part Drawings Online!

Nordson MEDICAL provides dimensional drawings available for download for all of its fittings.
www.nordsonmedical.com

LinkTech Line Part Number Guide

60	PP	- S	2	- 08
Flow Size or Latch Type	Material	Valve Config.	O-Ring Type	Connection Size



Reference part shown: 60PP-PE2-04

60PP-PE2-04

LinkTech 60PP Series Straight Male, Non-Valved, 1/4" Hose Barb, Polypropylene, EPDM O-ring

60PP-PE2-04BLK

LinkTech 60PP Series Straight Male, Non-Valved, 1/4" Hose Barb, Molded Black Color, Polypropylene, EPDM O-ring

60PP-PE2-08

LinkTech 60PP Series Straight Male, Non-Valved, 1/2" Hose Barb, Polypropylene, EPDM O-ring

60PS-PE1-08

LinkTech 60PS Series Male Thread Male, Non-Valved, 1/2" MNPT, Polysulfone, EPDM O-ring



Reference part shown: 60PP-PE4-08

60PP-PE4-08

LinkTech 60PP Series Elbow Male, Non-Valved, 1/2" Hose Barb, Polypropylene, EPDM O-ring

60PS-PE4-06

LinkTech 60PS Series Elbow Male, Non-Valved, 3/8" Hose Barb, Polysulfone, EPDM O-ring

60PS-PE22-06

LinkTech 60PS Series Panel Mount Elbow Male, Non-Valved, 3/8" Hose Barb, Polysulfone, EPDM O-ring



Reference part shown: 60PP-S3-08

60PP-S3-06

LinkTech 60PP Series Panel Mount Female, Non-Valved, 3/8" Hose Barb, Polypropylene

60PP-S3-08

LinkTech 60PP Series Panel Mount Female, Non-Valved, 1/2" Hose Barb, Polypropylene

60PS-S3-08BLK

LinkTech 60PS Series Panel Mount Female, Non-Valved, 1/2" Hose Barb, Molded Black Color, Polysulfone

Looking for Something Different?

Most of our best product ideas have come from you, our customers. While we pride ourselves on our extensive product offering, we recognize that your needs are ever-changing and that our products, too, must adapt to your needs.

If there's a new product you think Nordson MEDICAL should make, please send us an Email at Orders@nordsonmedical.com describing your product concept in as much detail as you desire. We will contact you with any questions, and who knows - the next catalog edition could include products YOU told us to build.

See page 8-9 for more information on custom engineered solutions!





Reference part shown: 60PPV-SE2-08

60PPV-SE1-06

LinkTech 60PP Series Male Thread Female, Valved, 3/8" MNPT, Polypropylene, EPDM O-ring

60PPV-SE1-08

LinkTech 60PP Series Male Thread Female, Valved, 1/2" MNPT, Polypropylene, EPDM O-ring

60PPV-SE1-08BLK

LinkTech 60PP Series Male Thread Female, Valved, 1/2" MNPT, Molded Black Color, Polypropylene, EPDM O-ring

60PPV-SE2-06

LinkTech 60PP Series Straight Female, Valved, 3/8" Hose Barb, Polypropylene, EPDM O-ring

60PPV-SE2-06BLK

LinkTech 60PP Series Straight Female, Valved, 3/8" Hose Barb, Molded Black Color, Polypropylene, EPDM O-ring

60PPV-SE2-08

LinkTech 60PP Series Straight Female, Valved, 1/2" Hose Barb, Polypropylene, EPDM O-ring

60PPV-SE2-08BLK

LinkTech 60PP Series Straight Female, Valved, 1/2" Hose Barb, Molded Black Color, Polypropylene, EPDM O-ring

60PSV-SE1-06

LinkTech 60PS Series Male Thread Female, Valved, 3/8" MNPT, Polysulfone, EPDM O-ring

60PSV-SE1-08

LinkTech 60PS Series Male Thread Female, Valved, 1/2" MNPT, Polysulfone, EPDM O-ring

60PSV-SE2-06

LinkTech 60PS Series Straight Female, Valved, 3/8" Hose Barb, Polysulfone, EPDM O-ring

60PSV-SE2-08

LinkTech 60PS Series Straight Female, Valved, 1/2" Hose Barb, Polysulfone, EPDM O-ring



Reference part shown: 60PPV-PE2-08

60PPV-PE1-08

LinkTech 60PP Series Male Thread Male, Valved, 1/2" MNPT, Polypropylene, EPDM O-ring

60PPV-PE1-08BLK

LinkTech 60PP Series Male Thread Male, Valved, 1/2" MNPT, Molded Black Color, Polypropylene, EPDM O-ring

60PPV-PE2-04BLK

LinkTech 60PP Series Straight Male, Valved, 1/4" Hose Barb, Molded Black Color, Polypropylene, EPDM O-ring

60PPV-PE2-06

LinkTech 60PP Series Straight Male, Valved, 3/8" Hose Barb, Polypropylene, EPDM O-ring

60PPV-PE2-06BLK

LinkTech 60PP Series Straight Male, Valved, 3/8" Hose Barb, Molded Black Color, Polypropylene, EPDM O-ring

60PPV-PE2-08

LinkTech 60PP Series Straight Male, Valved, 1/2" Hose Barb, Polypropylene, EPDM O-ring

60PPV-PE2-12

LinkTech 60PP Series Straight Male, Valved, 3/4" Hose Barb, Polypropylene, EPDM O-ring

60PSV-PE1-06

LinkTech 60PS Series Male Thread Male, Valved, 3/8" MNPT, Polysulfone, EPDM O-ring

60PSV-PE2-08

LinkTech 60PS Series Straight Male, Valved, 1/2" Hose Barb, Polysulfone, EPDM O-ring

Need More Details?

Part drawings, minimum order quantities, and CAD requests can be found online. Visit www.nordsonmedical.com or contact Sales at Orders@nordsonmedical.com.



Reference part shown: 60PPV-SE3-08

60PPV-SE3-06

LinkTech 60PP Series Panel Mount Female, Valved, 3/8" Hose Barb, Polypropylene, EPDM O-ring

60PPV-SE3-08

LinkTech 60PP Series Panel Mount Female, Valved, 1/2" Hose Barb, Polypropylene, EPDM O-ring

60PSV-SE3-12BLK

LinkTech 60PS Series Panel Mount Female, Valved, 3/4" Hose Barb, Molded Black Color, Polysulfone, EPDM O-ring

Reference part shown: 60PPV-PE4-08

60PPV-PE4-06

LinkTech 60PP Series Elbow Male, Valved, 3/8" Hose Barb, Polypropylene, EPDM O-ring

60PPV-PE4-08

LinkTech 60PP Series Elbow Male, Valved, 1/2" Hose Barb, Polypropylene, EPDM O-ring

60PPV-PE22-08BLK

LinkTech 60PP Series Panel Mount Elbow Male, Valved, 1/2" Hose Barb, Molded Black Color, Polypropylene, EPDM O-ring

QUICK
CONNECTS



Reference part shown: 60PPV-PE3-06

60PPV-PE3-06

LinkTech 60PP Series Panel Mount Male, Valved, 3/8" Hose Barb, Polypropylene, EPDM O-ring

60PSV-PE3-06

LinkTech 60PS Series Panel Mount Male, Valved, 3/8" Hose Barb, Polysulfone, EPDM O-ring

60PSV-PE3-06BLK

LinkTech 60PS Series Panel Mount Male, Valved, 3/8" Hose Barb, Molded Black Color, Polysulfone, EPDM O-ring

Did You Know?

Nordson MEDICAL has an interactive PDF available online at www.nordsonmedical.com. Access part drawings, reference charts, data sheets, and more from just one location!

Custom Assembly

We produce standard components to fit your current assemblies and devices, but we also provide custom solutions by applying a variety of assembly options, such as joining fittings, connectors, filters, and other components to tubing. From systems using a single fitting to complex configurations utilizing various components, we can design complete assemblies to your requirements.

65 Series

Quick Connect Couplings

65 SERIES - 1/2" FLOW SIZE: Female Open Flow Straight

QUICK
CONNECTS



Reference part shown: 65GP-S2-12

65GP-S2-12

LinkTech 65GP Series Straight Female, Non-Valved, 3/4" Hose Barb, Glass-Filled Polypropylene

65 SERIES - 1/2" FLOW SIZE: Male Open Flow Straight



Reference part shown: 65GP-PF1-08

65GP-PF1-08

LinkTech 65GP Series Male Thread Male, Non-Valved, 1/2" MNPT, Glass-Filled Polypropylene, Food Grade EPDM O-ring

65GP-PF2-08

LinkTech 65GP Series Straight Male, Non-Valved, 1/2" Hose Barb, Glass-Filled Polypropylene, Food Grade EPDM O-ring

Custom Assembly

We produce standard components to fit your current assemblies and devices, but we also provide custom solutions by applying a variety of assembly options, such as joining fittings, connectors, filters, and other components to tubing. From systems using a single fitting to complex configurations utilizing various components, we can design complete assemblies to your requirements.

Looking for Something Different?

Most of our best product ideas have come from you, our customers. While we pride ourselves on our extensive product offering, we recognize that your needs are ever-changing and that our products, too, must adapt to your needs.

If there's a new product you think Nordson MEDICAL should make, please send us an Email at Orders@nordsonmedical.com describing your product concept in as much detail as you desire. We will contact you with any questions, and who knows - the next catalog edition could include products YOU told us to build.

See page 8-9 for more information on custom engineered solutions!



100Series

Quick Connect Couplings

100 SERIES - 1/16" FLOW SIZE: Female Open Flow Straight



Reference part shown: 100AC-S2-M3

100AC-S2-01

LinkTech 100AC Series Straight Female, Non-Valved, 1/16" Hose Barb, Acetal

100AC-S2-M3

LinkTech 100AC Series Straight Female, Non-Valved, 3 mm Hose Barb, Acetal

100PP-S2-M3

LinkTech 100PP Series Straight Female, Non-Valved, 3 mm Hose Barb, Polypropylene

100 SERIES - 1/16" FLOW SIZE: Male Open Flow Straight



Reference part shown: 100AC-PB2-02

100AC-PB2-01

LinkTech 100AC Series Straight Male, Non-Valved, 1/16" Hose Barb, Acetal, Buna-N O-ring

100AC-PB2-02

LinkTech 100AC Series Straight Male, Non-Valved, 1/8" Hose Barb, Acetal, Buna-N O-ring



Reference part shown: 100ACV-SB2-01

100ACV-SB2-01

LinkTech 100AC Series Straight Female, Valved, 1/16" Hose Barb, Acetal, Buna-N O-ring

100 SERIES - 1/16" FLOW SIZE: Male and Female Sets



Reference part shown: 100AC2-M3

100AC2-M3

LinkTech 100AC Series Straight Coupling, Non-Valved, 3 mm Hose Barb, Acetal, Buna-N O-ring

100ACV2-M3

LinkTech 100AC Series Straight Coupling, Valved, 3 mm Hose Barb, Acetal, Buna-N O-ring

100PP2-02

LinkTech 100PP Series Straight Coupling, Non-Valved, 1/8" Hose Barb, Polypropylene, EPDM O-ring

100PP2-M3

LinkTech 100PP Series Straight Coupling, Non-Valved, 3 mm Hose Barb, Polypropylene, EPDM O-ring

QUICK
CONNECTS

MQC Series

Quick Connect Couplings

MQC SERIES: Female Open Flow Straight



Reference part shown: MQCF230

MQCF230 (-2 -3 -4 -5 -8)

Dual Latch Quick Connect Female 200 Series Barb 1/8" (3.2 mm) Tubing ID

MQCF240 (-2 -3 -4 -5 -8)

Dual Latch Quick Connect Female 200 Series Barb 5/32" (4.0 mm) Tubing ID

MQCF250 (-1 -2 -3 -4 -5 -8)

Dual Latch Quick Connect Female 200 Series Barb 3/16" (4.8 mm) Tubing ID

MQC SERIES: Male Open Flow Straight



Reference part shown: MQCRM230

MQCRM230 (-001 -002 -003 -004 -005 -08B)

Nylon, Buna-N O-Ring

Dual Latch Quick Connect Male 200 Series Barb 1/8" (3.2 mm) Tubing ID

MQCRM240 (-001 -002 -003 -004 -005 -08B)

Nylon, Buna-N O-Ring

Dual Latch Quick Connect Male 200 Series Barb 5/32" (4.0 mm) Tubing ID

MQCRM250 (-001 -002 -003 -004 -005 -08B)

Nylon, Buna-N O-Ring

Dual Latch Quick Connect Male 200 Series Barb 3/16" (4.8 mm) Tubing ID



Reference part shown: MQCMF230

MQCMF230-901

Bag of 50 Dual Latch Quick Connect Male and Female Sets, 200 Series Barb 1/8" (3.2 mm) Tubing ID, Blue Female and White Male

MQCMF240-901

Bag of 50 Dual Latch Quick Connect Male and Female Sets, 200 Series Barb 5/32" (4.0 mm) Tubing ID, Blue Female and White Male

MQCMF250-901

Bag of 50 Dual Latch Quick Connect Male and Female Sets, 200 Series Barb 3/16" (4.8 mm) Tubing ID, Blue Female and White Male

Need it Fast?

You can order our parts online now with no order \$ minimums, 24 hours a day, 7 days a week!

www.nordsonmedical.com

Part Drawings Online!

Nordson MEDICAL provides dimensional drawings available for download for all of its fittings.

www.nordsonmedical.com

Technical Assistance

Trying to choose the correct part? Need more material information than is published in this catalog? Call Nordson MEDICAL Technical Support **(970) 267-5200**.

RQ Series

Quick Connect Couplings

RQ SERIES: Female Open Flow Straight



Reference part shown: RQXF670-9024

RQCF655 (-9024 -001)

RQCF655 (-6005 -001)

Female Open Flow, 600 Series Barb, 1/4" (6.4 mm) Tubing ID

RQCF670 (-9024 -001)

RQCF670 (-6005 -001)

Female Open Flow, 600 Series Barb, 3/8" (9.5 mm) Tubing ID

RQXF670 (-9024 -001)

RQXF670 (-6005 -001)

Female Open Flow, 600 Series Barb, 3/8" (9.5 mm) Tubing ID

RQXF680 (-6005 -001)

Female Open Flow, 600 Series Barb, 1/2" (12.7 mm) Tubing ID

RQ SERIES: Male Open Flow Straight



Reference part shown: RQXM670-9024

RQCM655 (-6005 -001) Platinum-Cured Silicone O-Ring

Male Open Flow, 600 Series Barb, 1/4" (6.4 mm) Tubing ID

RQCM670 (-9024 -001) Platinum-Cured Silicone O-Ring

RQCM670 (-6005 -001) Platinum-Cured Silicone O-Ring

Male Open Flow, 600 Series Barb, 3/8" (9.5 mm) Tubing ID

RQXM670 (-9024 -001) Platinum-Cured Silicone O-Ring

Male Open Flow, 600 Series Barb, 3/8" (9.5 mm) Tubing ID

RQXM680 (-6005 -001) Platinum-Cured Silicone O-Ring

Male Open Flow, 600 Series Barb, 1/2" (12.7 mm) Tubing ID



Reference part shown: RQCFLC-9024

RQCFC (-9024 -001)

Female Cap

RQCFLC (-9024 -001)

Female Cap, Locking Feature

RQXFC (-6005 -001)

Female Cap

RQ SERIES: Plugs



Reference part shown: RQXMP-9024

RQCMP (-6005 -001) Platinum-Cured Silicone O-Ring

Male Plug

RQXMP (-9024 -001) Platinum-Cured Silicone O-Ring

RQXMP (-6005 -001) Platinum-Cured Silicone O-Ring

Male Plug

Need Samples for Evaluation?

You can call to request most of our standard product in quantities of 5, or less, for free application evaluation.

+1 (970) 267-5200 Toll Free: (888) 404-5837

QUICK
CONNECTS

SBL Series

Quick Connect Couplings

SBL SERIES:
Female Open Flow Straight



Reference part shown: SBLF035-8B

SBLF013 (-1 -2 -8B)

Side Latch Quick Connect Female 500 Series Barb, 1/8" (3.2 mm) Tubing ID

SBLF035 (-1 -2 -8B -CM030)

Side Latch Quick Connect Female 500 Series Barb, 3/16" (4.8 mm) Tubing ID

SBL SERIES:
Male Open Flow Straight



Reference part shown: SBLM013-001

SBLM013 (-004 -005) Nylon, Buna-N O-Ring

Side Latch Quick Connect Male 500 Series Barb, 1/8" (3.2 mm) Tubing ID

SBLM035 (-001 -002 -004 -005) Nylon, Buna-N O-Ring

Side Latch Quick Connect Male 500 Series Barb, 3/16" (4.8 mm) Tubing ID



Reference part shown: SBLMFGB035-003

SBLMFGB013 (-002)

Bag of 50 Side Latch Quick Connect Male and Female Sets, 500 Series Barb 1/8" (3.2 mm) Tubing ID, Blue Male and Grey Female Nylon

SBLMFGB035 (-004)

Bag of 50 Side Latch Quick Connect Male and Female Sets, 500 Series Barb 3/16" (4.8 mm) Tubing ID, Blue Male and Grey Female Nylon

SBLMFGB013 (-001)

Bag of 50 Side Latch Quick Connect Male and Female Sets, 500 Series Barb 1/8" (3.2 mm) Tubing ID, Grey Male and Blue Female Nylon

SBLMFGB035 (-003)

Bag of 50 Side Latch Quick Connect Male and Female Sets, 500 Series Barb 3/16" (4.8 mm) Tubing ID, Grey Male and Blue Female Nylon

Looking for Something Different?

Most of our best product ideas have come from you, our customers. While we pride ourselves on our extensive product offering, we recognize that your needs are ever-changing and that our products, too, must adapt to your needs.

If there's a new product you think Nordson MEDICAL should make, please send us an Email at Orders@nordsonmedical.com describing your product concept in as much detail as you desire. We will contact you with any questions, and who knows - the next catalog edition could include products YOU told us to build.

See page 8-9 for more information on custom engineered solutions!



XQ Series

Quick Connect Couplings

XQ SERIES - 1/4" FLOW SIZE:
Male Open Flow Straight



Reference part shown: XQCM755

XQCM755 (-1006-B)

XQ Series Male Open Flow Connector, 700 Series Barb, 1/4" (6.4 mm) Tubing ID

XQCM770 (-1006-B)

XQ Series Male Open Flow Connector, 700 Series Barb, 3/8" (9.5 mm) Tubing ID

XQ SERIES - 1/4" FLOW SIZE:
Male Open Flow Elbow



Reference part shown: XQCLM770

XQCLM770 (-1006-B)

XQ Series Male Open Flow Elbow Connector, 700 Series Barb, 3/8" (9.5 mm) Tubing ID



Reference part shown: XQSVF755

XQSVF755 (-1006-B -1007-B)

XQ Series Female Valved Connector, 700 Series Barb, 1/4" (6.4 mm) Tubing ID

XQSVF765 (-1007-B)

XQ Series Female Valved Connector, 700 Series Barb, 5/16" (8.0 mm) Tubing ID

XQSVF770 (-1006-B)

XQ Series Female Valved Connector, 700 Series Barb, 3/8" (9.5 mm) Tubing ID

QUICK
CONNECTS

XQ SERIES - 1/4" FLOW SIZE:
Male Valved Straight



Reference part shown: XQCVM755

XQCVM755 (-1006-B)

XQ Series Male Valved Connector, 700 Series Barb, 1/4" (6.4 mm) Tubing ID

XQCVM765 (-1007-B)

XQ Series Male Valved Connector, 700 Series Barb, 5/16" (7.9 mm) Tubing ID

XQCVM770 (-1006-B)

XQ Series Male Valved Connector, 700 Series Barb, 3/8" (9.5 mm) Tubing ID

XQ SERIES - 1/4" FLOW SIZE:
Panel Mount Nut

PM4N (Nickel-Plated Brass)

XQ Series 11/16-24 UNEF Panel Mount Nut



FILTRATION Connectors

Quick Connect Couplings

QUICK
CONNECTS

FILTRATION CONNECTORS: Female Open Flow Straight



Reference part shown: 40CB-S35296

40CB-S35296

LinkTech 40CB Series Female Connector, Non-valved, 1/2" IPS Female Sink Thread, w/NBR Gasket, Chrome Brass

40CB-S3557

LinkTech 40CB Series Female Connector, Non-valved, 15/16-27 Male Sink Thread, w/NBR Gasket, Chrome Brass

40CB-S3559

LinkTech 40CB Series Female Connector, Non-valved, 55/64-27 Female Sink Thread, w/NBR Gasket, Chrome Brass

FILTRATION CONNECTORS: Female Valved Straight



Reference part shown: 40CB-S35271

40CB-S35271

LinkTech 40CB Series Compact Female Connector, Valved, M24X1 Male Sink Thread, w/NBR Gasket, Chrome Brass

40CB-S35288

LinkTech 40CB Series Compact Female Connector, Valved, M22X1 Female Thread, w/NBR Gasket, Chrome Brass

40CBV-S35297

LinkTech 40CB Series Female Connector, Valved, 1/2" IPS Male Sink Thread, w/VITON O-ring, Chrome Brass

FILTRATION CONNECTORS: Male Valved Straight



Reference part shown: 40CBV-P75242

40CBV-P75242

LinkTech 40CB Series Male Connector, Valved, 1/2" IPS Female Sink Thread, w/VITON Gasket & Viton O-rings, Chrome Brass

Did You Know?

Nordson MEDICAL has an interactive PDF available online at www.nordsonmedical.com. Access part drawings, reference charts, data sheets, and more from just one location!

Custom Assembly

We produce standard components to fit your current assemblies and devices, but we also provide custom solutions by applying a variety of assembly options, such as joining fittings, connectors, filters, and other components to tubing. From systems using a single fitting to complex configurations utilizing various components, we can design complete assemblies to your requirements.

Need More Details?

Part drawings, minimum order quantities, and CAD requests can be found online. Visit www.nordsonmedical.com or contact Sales at Orders@nordsonmedical.com.

CUSTOM

Solutions

Nordson MEDICAL has developed hundreds of custom connection solutions for challenging applications. Our engineering staff is ready to work with your designers to solve application problems beyond the scope of our standard product offering. Whether it is a simple o-ring, color change, or a completely new and unique design, Nordson MEDICAL offers its customers the best possible solution. To submit a new product request, email us at designcenter@nordsonmedical.com.

CUSTOM SOLUTIONS: Multi-port Couplings



CUSTOM SOLUTIONS: Unique Valved Couplings



CUSTOM SOLUTIONS: Value Added Services



CUSTOM SOLUTIONS: Molded Color Couplings



CUSTOM SOLUTIONS: Non-Spill Capabilities



CUSTOM SOLUTIONS: Non-Standard, High Performance Materials



CUSTOM SOLUTIONS: Custom Mounting Options



QUICK
CONNECTS

CHECK

VALVES



Anti-Siphon Check Valves

PG-66



High Flow Check Valves

PG-67



One-Way Check Valves

PG-67



Barbed Check Valves

PG-68



Double Check Valves

PG-69



SCV Series

Check Valves

SCV Series products are available in barbed, anti-siphon or one-way check valve configurations in a variety of materials and end fittings. Barbed check valves reduce the risk of contamination and feature more precise, lower crack pressures and higher flow rates. They are ideal for medical device designers focused on infusion, drainage and irrigation applications. All the valves feature a low priming volume, ease of removing air bubbles during priming and operate in any spatial orientation. All materials of construction satisfy USP Class VI and ISO 10993 criteria.

Features & Benefits:

- Materials meet USP Class VI and ISO 10993 criteria
- DEHP- and latex-free silicone diaphragms
- All products are suitable for EtO or gamma sterilization
- Several connection configurations and materials
- Air bubbles completely removable during priming
- Operate in any spatial orientation
- Normally closed valve positioning for optimum flow control
- Available with the lowest cracking pressure on the market
- Air entrapment readily alleviated during priming

SCV SERIES:

Anti-Siphon Check Valves

SCV06246 (Clear Transparent MABS and Blue Transparent SAN w/Silicone Diaphragm)

Check Valve, Pocket for .122" (3.1 mm) OD Tubing to Male Locking Luer



Cracking Pressure: 2.9 +/- 0.725 psig
Max. Back Pressure: 304.5 psig
Flow Rate: \geq 150 ml/min
Flow Direction: Left to right

SCV06252 (Clear Transparent SAN and Blue Transparent SAN w/Silicone Diaphragm)

Check Valve, Female Locking Luer to Male Locking Luer



Cracking Pressure: 2.9 +/- 0.725 psig
Max. Back Pressure: 304.5 psig
Flow Rate with Glucose: \geq 150 ml/min
Flow Direction: Left to right

SCV SERIES: Anti-Siphon Check Valves

SCV06264 (Clear and Blue MABS w/Silicone Diaphragm)

Check Valve, Pocket for .161" (4.0 mm) OD Tubing to .161" (4.0 mm) OD Tubing



Cracking Pressure: 1.450-4.351 psig
Max. Back Pressure: 304.579 psig
Flow Rate: max 200 ml/min
Flow Direction: Left to right

SCV06308 (Clear Transparent Polycarbonate and Green Polycarbonate w/Silicone Diaphragm)

Check Valve, Female Locking Luer to Pocket for .098" (2.5 mm) OD Tubing



Cracking Pressure: 2.9 +/- 0.725 psig
Max. Back Pressure: 304.5 psig
Flow Rate with Glucose: ≥ 150 ml/min
Flow Direction: Left to right

SCV06329 (Clear and Blue SAN w/Silicone Diaphragm)

Check Valve, Female Locking Luer Linden



Cracking Pressure: 1.450-4.351 psig
Max. Back Pressure: 304.579 psig
max 30 sec.
Flow Rate: 200 ml/min
Flow Direction: Left to right

SCV06397 (Clear MABS w/Silicone Diaphragm)

High Flow Check Valve, Pocket for 8.8 mm OD Tubing to Pocket for 8.8 mm OD Tubing



Cracking Pressure: < .29 psig
Max. Back Pressure: 14.500 psig
Flow Rate with Water at 100 mbar:
> 1000 ml/min
Flow Direction: Left to right

SCV06398 (Clear MABS w/Silicone Diaphragm)

High Flow Check Valve, Pocket for 6.8 mm OD Tubing to Pocket for 6.8 mm OD Tubing



Cracking Pressure: < .29 psig
Max. Back Pressure: 14.500 psig
Flow Rate with Water at 100 mbar:
> 1000 ml/min
Flow Direction: Left to right

SCV SERIES: One-Way Check Valves

SCV06265 (Blue and Clear Polycarbonate w/Silicone Diaphragm)

Check Valve, Autoclavable, Socket for .122" (3.1 mm) ID x .165" (4.2 mm) OD Tubing x 2



Cracking Pressure: ≤ .087 psig
Max. Back Pressure: 73 psig
Flow Rate: ≥ 150 ml/min
Flow Direction: Left to right

SCV08053 (White SAN w/Silicone Diaphragm w/Natural LDPE)

Check Valve, Female Locking Luer to Male Locking Luer w/Cap



Cracking Pressure: ≤ .174 psig
Max. Back Pressure: 87.023 psig
Flow Rate: ≥ 90 ml/min
Flow Direction: Left to right

SCV10090 (Clear Polycarbonate w/Silicone Diaphragm)

Check Valve, Female Locking Luer to Pocket for .118" (3.0 mm) OD Tubing



Cracking Pressure: ≤ .174 psig
Max. Back Pressure: 87.023 psig
Flow Rate: ≥ 90 ml/min
Flow Direction: Left to right

SCV17090 (Clear Polycarbonate w/Silicone Diaphragm)

Check Valve, Female Locking Luer to Socket for .118" (3.0 mm) ID x .161" (4.1 mm) OD Tubing



Cracking Pressure: ≤ .174 psig
Max. Back Pressure: 87.023 psig
Flow Rate: ≥ 90 ml/min
Flow Direction: Left to right

SCV21053 (Clear and White MABS w/Silicone Diaphragm)

Check Valve, Socket for .118" (3.0 mm) ID x .161" (4.1 mm) OD Tubing x 2



Cracking Pressure: ≤ .174 psig
Max. Back Pressure: 87.023 psig
Flow Rate: ≥ 90 ml/min
Flow Direction: Left to right

SCV22050 (Clear SAN and Clear MABS w/Silicone Diaphragm)

Check Valve, Socket for .118" (3.0 mm) ID x .161" (4.1 mm) OD to Male Locking Luer



Cracking Pressure: ≤ .174 psig
Max. Back Pressure: 87.023 psig
Flow Rate: ≥ 90 ml/min
Flow Direction: Left to right

SCV SERIES: One-Way Check Valves

SCV23050 (Clear SAN w/Silicone Diaphragm)

Check Valve, Female Locking Luer to Male Locking Luer



Cracking Pressure: $\leq .174$ psig
Max. Back Pressure: 87.023 psig
Flow Rate: ≥ 90 ml/min
Flow Direction: Left to right

VPS5401001N (ABS Housing with Silicone Disk)

Check Valve, Male Slip Luer, 420 mL/min Flow Rate at 1M Head, 30 psi Back Pressure, 1/4 psi Inlet Cracking Pressure



VPS5401020N (Polycarbonate with Silicone Disk)

Check Valve, Male/Female Luer, 129 mL/min Flow Rate at 100 mmHg, 45 psi Back Pressure, 1-5 psi Inlet Cracking Pressure



VPS5401036SN (Polycarbonate with Silicone Disk)

Reflux Check Valve, Male/Female Luer, 350 mL/min Flow Rate at 1 M Head, 45 psi Back Pressure, Opens at 284 mmHg



VPS5401068N (Polycarbonate with Silicone Disk)

Check Valve, Male/Female Luer, 420 mL/min Flow Rate at 1 M Head 30 psi Back Pressure, 1/4 psi Inlet Cracking Pressure



SCV SERIES: Barbed Check Valves

SCV67FL/220 (SAN and MABS w/Silicone Diaphragm)

Check Valve, Female Locking Luer to Barb for 3/32" (2.4 mm) ID Tubing



Cracking Pressure: $\leq .087$ psig
Max. Back Pressure: 73 psig
Flow Rate: ≥ 150 ml/min
Flow Direction: Left to right

SCV67FL/230 (SAN and MABS w/Silicone Diaphragm)

Check Valve, Female Locking Luer to Barb for 1/8" (3.2 mm) ID Tubing



Cracking Pressure: $\leq .087$ psig
Max. Back Pressure: 73 psig
Flow Rate: ≥ 150 ml/min
Flow Direction: Left to right

SCV67220 (MABS w/Silicone Diaphragm)

Check Valve, Socket for 3/32" (2.4 mm) x 3/32" (2.4 mm) ID Tubing



Cracking Pressure: $\leq .087$ psig
Max. Back Pressure: 73 psig
Flow Rate: ≥ 150 ml/min
Flow Direction: Left to right

SCV67220/230 (MABS w/Silicone Diaphragm)

Check Valve, Socket for 3/32" (2.4 mm) x 1/8" (3.2 mm) ID Tubing



Cracking Pressure: $\leq .087$ psig
Max. Back Pressure: 73 psig
Flow Rate: ≥ 150 ml/min
Flow Direction: Left to right

SCV67220/ML (SAN and MABS w/Silicone Diaphragm)

Check Valve, Socket for 3/32" (2.4 mm) ID Tubing to Male Locking Luer



Cracking Pressure: $\leq .087$ psig
Max. Back Pressure: 73 psig
Flow Rate: ≥ 150 ml/min
Flow Direction: Left to right

SCV67230 (MABS w/Silicone Diaphragm)

Check Valve, Socket for 1/8" (3.2 mm) x 1/8" (3.2 mm) ID Tubing



Cracking Pressure: $\leq .087$ psig
Max. Back Pressure: 73 psig
Flow Rate: ≥ 150 ml/min
Flow Direction: Left to right

SCV67230/220 (MABS w/Silicone Diaphragm)

Check Valve, Socket for 1/8" (3.2 mm) x 3/32" (2.4 mm) ID Tubing



Cracking Pressure: $\leq .087$ psig
Max. Back Pressure: 73 psig
Flow Rate: ≥ 150 ml/min
Flow Direction: Left to right

SCV67230/ML (SAN and MABS w/Silicone Diaphragm)

Check Valve, Socket for 1/8" (3.2 mm) ID Tubing to Male Locking Luer



Cracking Pressure: $\leq .087$ psig
Max. Back Pressure: 73 psig
Flow Rate: ≥ 150 ml/min
Flow Direction: Left to right

DCV Series

Check Valves

Nordson MEDICAL's unique DCV Series bi-directional double check valve is designed to transfer clean fluid from a supply vessel to a use site. The fluid supply vessel is connected to the valve supply port (chimney) using a luer connection or tubing. The fluid is withdrawn from the supply vessel by a syringe or other device connected to the aspiration port. When the syringe is compressed the fluid is then transferred, through the exit port, to the use site without adulterating the fluid. DCV Series bi-directional valves are produced in polycarbonate resin using a silicone diaphragm, with two available inlet ports connecting to the female luer aspiration and male luer discharge ports.

Features & Benefits:

- Bi-directional double check valve
- No need for disconnection to fill syringe
- Satisfies USP Class VI criteria
- Low cracking pressure
- Clean fluid transfer from supply to site
- High flow rate

DCV SERIES: Double Check Valves, Tubing Pocket Chimney Port

DCV114 (-001) Radiation-Stable Polycarbonate

Double Check Valve, Tubing Pocket Chimney Port

Cracking Pressure: 2-5 psi



DCV115 (-001) Radiation-Stable Polycarbonate

Double Check Valve, Tubing Pocket Chimney Port, Rotating Luer Lock Exit Port

Cracking Pressure: 2-5 psi



DCV SERIES: Double Check Valves, Female Luer Chimney Port

DCV118 (-001) Radiation-Stable Polycarbonate

Double Check Valve, Female Luer Chimney Port

Cracking Pressure: 2-5 psi



DCV125 (-001) Radiation-Stable Polycarbonate

Double Check Valve, Female Luer Chimney Port, Rotating Luer Lock Exit Port

Cracking Pressure: 2-5 psi

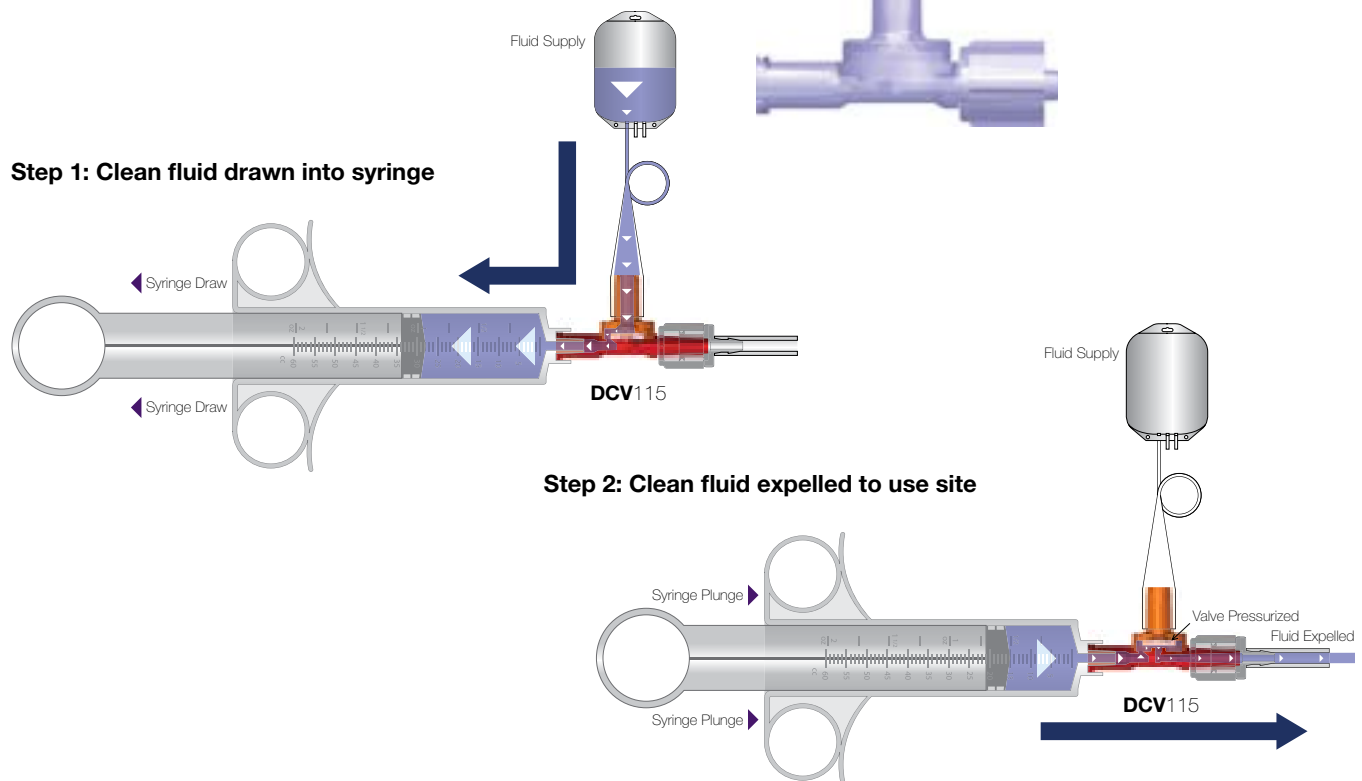

NEEDLEFREE

SWABABLE VALVES



Vial Caps
PG-70

Swabable Bag Valves
PG-71



Valved Male Luers
PG-71

Swabable Break-Off
Valves **PG-71**



Swabable 'Y' Valves
PG-71

Swabable Straight
Valves **PG-71**



Bondable Valves
PG-71



NV Series

Needlefree Swabable Valves

Nordson MEDICAL now offers cost efficient needlefree swabable valves featuring higher flow rates, low priming volumes, and a straight through design for unobstructed flow. The valves don't require caps, and the septum surface can be easily disinfected. Designed for the injection and aspiration of fluids, particularly for IV applications, cardiology, and catheters, the hermetic septum seal reduces the risk of biofilm formation and contamination. Available in widely used polycarbonate and copolyester materials, these valves are compatible with all industry standard luer syringes and connects, validating them as an efficient component solution for the OEM market.

Features & Benefits:

- Valve stems and bodies securely mate with all standard luer syringes and connectors
- Several configurations that are easy to customize
- Normally closed system to reduce the risk of infection
- Low priming volume and high flow rates
- Straight through design for unobstructed flow
- Gamma radiation stable and EtO compatible
- Not made with natural rubber latex or DEHP

The NV Series products are shipped bulk, non-sterile and are single patient use medical device components requiring further processing (e.g. assembly, packaging, sterilization) before clinical use. The buyer is responsible for determining effects of processing/multiple usage on these components, appropriateness of the component in the final application, and pre/post shelf life.

NV SERIES: Vial Caps

NVF13VPC (Polycarbonate)

13 mm Swabable Vial Cap, Female Luer to 13 mm Vial Cap



NV SERIES: Swabable Bag Valves

NVFBGPC (Polycarbonate)

Swabable Bag Valve, Female Luer to Bag Access Port



NV SERIES: Valved Male Luers

NVM41S-001 (Polycarbonate)

Valved Male Luer to 4.0 / 4.1 mm Bondable Socket



NV SERIES: Swabable Break-Off Valves

NVFBV60PC (Polycarbonate)

Swabable Break-Off Valve, Female Luer to Break Off 6.0 mm Port



NV SERIES: Swabable 'Y' Valves

NVfy42S-001 (Polycarbonate)

Swabable 'Y' Valve, Female Luer Y Port to 4.2 mm Bondable Sockets



NVfy401CP (Copolyester)

Swabable 'Y' Valve, Female Luer Y Port to 4.01 mm Tube Sockets



NVfy401PC (Polycarbonate)

Swabable 'Y' Valve, Female Luer Y Port to 4.01 mm Tube Sockets



NV SERIES: Swabable Straight Valves

NVFMLLCP (Copolyester)

Swabable Straight Valve, Female Luer to Male Luer Lock



NVFMLLPC (Polycarbonate)

Swabable Straight Valve, Female Luer to Male Luer Lock



NVFMLLS-001 (Polycarbonate)

Swabable Straight Valve, Female Luer to Male Luer Lock



NV SERIES: Bondable Valves

NVFMLPC (Polycarbonate)

Bondable Valve, Female Luer to Male Luer Slip



NVFMLPCB (Polycarbonate)

Bondable Valve, Female Luer to Male Luer Slip, Blue Cap



NEEDLEFREE
VALVES

Did You Know?

Nordson MEDICAL has an interactive PDF available online at www.nordsonmedical.com. Access part drawings, reference charts, data sheets, and more from just one location!



STOPCOCK

FITTINGS

Standard Pressure Stopcocks
PG-73



High Pressure Stopcocks
PG-73



DIVERT™

Stopcocks

Divert™ stopcocks are designed to easily control the flow of a liquid or gas through the use of an on/off diverter, and are available in two basic configurations – 1-way and 3-way. These chemically resistant stopcocks bring efficiency, convenience, and practicality to your tubing applications.

Features & Benefits:

- 1-way and 3-way configurations
- Chemically resistant
- Not made with DEHP
- Diverter arrows provide a clear indication of flow
- Custom solutions available, including manifolds, ganged manifolds, and tubing assemblies
- Standard flow and high flow options
- Polycarbonate, PEI, nylon, and HDPE materials

Polycarbonate is known to experience environmental stress cracking when exposed to solvents. Please contact Nordson MEDICAL technical support if polycarbonate is planning on being used in a solvent bonding application. Looking for a stress-free connection? Ask our technical experts at 1-888-404-5837 how annealing and other secondary processes can alleviate the risk of environmental stress cracking in polycarbonate materials.

Custom Assembly

We produce standard components to fit your current assemblies and devices, but we also provide custom solutions by applying a variety of assembly options, such as joining fittings, connectors, filters, and other components to tubing. From systems using a single fitting to complex configurations utilizing various components, we can design complete assemblies to your requirements.

DIVERT STOPCOCKS:
Standard Pressure Stopcocks

FCFFM-017

3-Way Stopcock, Female Luer to Female Luer to Bondable Socket, Clear Polycarbonate Body, 1-Arrow White HDPE Diverter



FCFFM-020

3-Way Stopcock, Female Luer to Female Luer to Male Luer, Clear Polycarbonate Body, 1-Arrow Natural HDPE Diverter



FCFFMR-007

3-Way Stopcock, Female Luer to Female Luer to Male Luer with Luer Lock Ring, Clear Polycarbonate Body and Lock Ring, 1-Arrow Natural HDPE Diverter



FCFM-006

1-Way Stopcock, Female Luer to Male Luer, Tinted Polycarbonate Body, 2-Arrow Natural HDPE Diverter



FCFMR-001

1-Way Non-Sterile Stopcock, Female Luer to Male Luer with Luer Lock Ring, Clear Polycarbonate Body, 2-Arrow Natural HDPE Diverter



FCLBFFMR-1A-003

3-Way High Flow Stopcock, Female Luer to Female Luer to Male Luer with Luer Lock Ring, Large Bore, Clear Polycarbonate Body and Lock Ring, 1-Arrow Natural HDPE Diverter



FCLBFMR-001

1-Way High Flow Stopcock, Female Luer to Male Luer with Luer Lock Ring, Large Bore, Clear Polycarbonate Body and Lock Ring, 2-Arrow Natural HDPE Diverter



FCVFFM-008

3-Way Stopcock, Female Luer to Female Luer to Male Luer, 80369-7 Compliant, Clear Polycarbonate Body, Natural HDPE Diverter



FCVFM-001

1-Way Low-Pressure Stopcock, Female Luer to Male Luer, 80369-7 Compliant, Radiation-Stable Polycarbonate Body, Natural HDPE Diverter



STOPCOCK
FITTINGS

DIVERT STOPCOCKS:
High Pressure Stopcocks

FCHPFFMR-003

3-Way High Pressure Stopcock, Female Luer to Female Luer to Male Luer with Luer Lock Ring, Clear Polycarbonate Body and Lock Ring, 4-Arrow Gold Color Acetal Diverter



FCHPFMR-002

1-Way High Pressure Stopcock, Female Luer to Male Luer with Luer Lock Ring, Clear Polycarbonate Body and Lock Ring, 2-Arrow Gold Color Acetal Diverter



BIOPROCESS

FITTINGS



Bag Ports
PG-74



BioProcessing Check
Valves **PG-77**



Opposing Barb
Ports **PG-78**



Pharma+ Tubing
Retainers **PG-79**



BioClamp®
PG-80



BioValve®
PG-81



PharmaLok™
Clamps **PG-82**



PharmaLok™ Tube
Clamps **PG-85**



Spaulding™ Aseptic
Disconnects **PG-86**



CYLINDRAFlow™
Manifolds **PG-88**



Sanitary Fittings
PG-89



Gaskets
PG-93



Large Tube Fittings
PG-95



Tube Fittings
PG-20



BAG

Ports

Nordson MEDICAL's new high tech series of bag ports offers a variety of benefits new to the biopharmaceutical industry through a unique design. Value Pharma™ resin holds credentials that many manufacturers deem fundamental, such as animal derivative free qualification, USP Class VI certification, and the guarantee of heat sealing and conformance with polyethylene bags. The resin then goes even further to provide a strong, 24-hour resistance to alcohol stress cracking. RENOLIT SOLMED Granuflex 4301 resin demonstrates lower leachable levels and high purity.

Their unique design sets these ports apart from existing solutions. The most notable of the bag ports' specifications are the parabolic lead and the alignment ribs. These two features, respectively, reduce the amount of time it takes to drain a bag by up to 24 percent and improve flow dynamics through the port.

- Works with leading industry single-use bags
- Works with the frequently utilized tubing sizes found in the pharmaceutical industry
- Allows the option to connect directly to sanitary TC fittings
- Ideal for dip tubes
- Reduces the time it takes to drain a bag by 17 to 24%
- Similar results for both fluid and powder applications
- Improves fluid dynamics of flow through the port
- Ensures heat sealing with polyethylene bags
- Includes a USP Class VI certification
- Animal derivative free
- Resistant to alcohol stress cracking
- Demonstrates lower leachable levels and high purity

BAG PORTS:
600 Series Barb Style

SFBP630 (-VP1) Value Pharma™ Resin
Bag Port with 600 Series Barb, 1/8" (3.2 mm) Tubing ID



SFBP655 (-VP1) Value Pharma™ Resin
Bag Port with 600 Series Barb, 1/4" (6.4 mm) Tubing ID



SFBP670 (-VP1) Value Pharma™ Resin
Bag Port with 600 Series Barb, 3/8" (9.5 mm) Tubing ID



BAG PORTS:
600 Series Barb Style

SFBP680 (-VP1) Value Pharma™ Resin
Bag Port with 600 Series Barb, 1/2" (12.7 mm) Tubing ID



SFBP6100 (-VP1) Value Pharma™ Resin
Bag Port with 600 Series Barb, 3/4" (19.0 mm) Tubing ID



SFBP6110 (-VP1) Value Pharma™ Resin
Bag Port with 600 Series Barb, 1" (25.4 mm) Tubing ID



Part Drawings Online!

Nordson MEDICAL provides dimensional drawings available for download for all of its fittings.
www.nordsonmedical.com

Need Samples for Evaluation?

You can call to request most of our standard product in quantities of 5, or less, for free application evaluation.
+1 (970) 267-5200 Toll Free: (888) 404-5837

BAG PORTS:
Ferrule Fitting to 1-1/2" TC Connection

SFBPF1 (-VP1) Value Pharma™ Resin
Bag Port with Ferrule Fitting to 1-1/2" TC Connection



Innovative Parabolic Lead & Alignment Ribs

BAG PORTS:
4" TC Connection

SFBPF4 (-VP1) Value Pharma™ Resin,
Bag Port with Ferrule Fitting to 4" TC Connection



BAG PORTS:
3" TC Connection

SFBPF3 (-VP1 -CM056) Value Pharma™ Resin,
Granuflex Polyethylene
Bag Port with Ferrule Fitting to 3" TC Connection



Need More Details?

Part drawings, minimum order quantities, and CAD requests can be found online. Visit www.nordsonmedical.com or contact Sales at Orders@nordsonmedical.com.

Need Samples for Evaluation?

You can call to request most of our standard product in quantities of 5, or less, for free application evaluation.
+1 (970) 267-5200 Toll Free: (888) 404-5837

SFM3C (-6005)

Flat TC Style End Cap, 3", Works with SFBPF3



SFM4C (-6005)

Flat TC Style End Cap, 4" (101.6 mm) Flange



BIOProcessing

Check Valves

Nordson MEDICAL now offers a reliable check valve. Our patented check valve design features a barb for a secure connection, and our normally closed pathway means you only get flow when you want it. Our biopharm-compatible materials meet USP Class VI and ISO 10993 criteria, making them the valves of choice for your applications. Now you can do even more in pharmaceutical development. Nordson MEDICAL's bioprocessing check valves control flow, restrict siphoning and backflow, and prevent contamination.

Features & Benefits:

- Designed to prevent backflow
- Biopharma-grade materials meet USP Class VI & ISO 10993 criteria
- No animal derivatives
- Barbs that work with tube clamps
- Normally closed valve for optimum flow control
- Clean room manufacturing
- Flow orientation by design

SCV655U50C050 (-001)

Normally Closed Check Valve Assembly, 600 Series Barb, 1/4" (6.4mm) ID Tubing, 0.5 psi Crack Pressure



Opening Pressure: 0.3 psi
Burst Pressure: 60 psi
Flow Direction: Left to right

BIOPROCESSING
FITTINGS

Custom Assembly

We produce standard components to fit your current assemblies and devices, but we also provide custom solutions by applying a variety of assembly options, such as joining fittings, connectors, filters, and other components to tubing. From systems using a single fitting to complex configurations utilizing various components, we can design complete assemblies to your requirements.

Need it Fast?

You can order our parts online now with no order \$ minimums, 24 hours a day, 7 days a week!

www.nordsonmedical.com

OPPOSING

Barb Ports

Nordson MEDICAL now offers the biomedical market opposing barb ports. The larger ports can be used in filling applications, and they are also ideally suited to work with sensors.

- Easy to heat seal into film material
- Can be used in filling applications
- Port plates featuring Value Pharma™ or Granuflex resin
- Works great with silicone and TPE style tubing
- Better tube retention
- 600 Series barb sizes
- Animal-free polyethylene
- Materials meet USP Class VI criteria and are ADF compliant
- Fits tubing sizes from 3/16" to 3/4"

OPPOSING BARB PORTS: 600 Series Barb Style

SFBP635/635 (-VP1) Value Pharma™ Resin

Dip Tube (Opposable Barbs) with Two 600 Series Barbs, 3/16" (4.8 mm) Tubing ID



SFBP655/655 (-VP1) Value Pharma™ Resin

Dip Tube (Opposable Barbs) with Two 600 Series Barbs, 1/4" (6.4 mm) Tubing ID



OPPOSING BARB PORTS: 600 Series Barb Style

SFBP670/670 (-VP1) Value Pharma™ Resin

Dip Tube (Opposable Barbs) with Two 600 Series Barbs, 3/8" (9.5 mm) Tubing ID

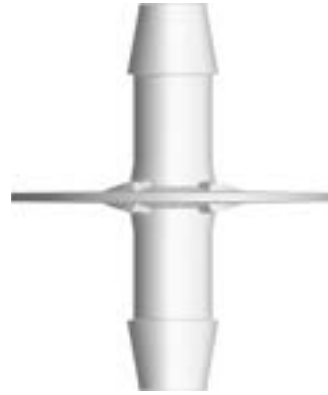

SFBP680/680 (-VP1) Value Pharma™ Resin

Dip Tube (Opposable Barbs) with Two 600 Series Barbs, 1/2" (12.7 mm) Tubing ID

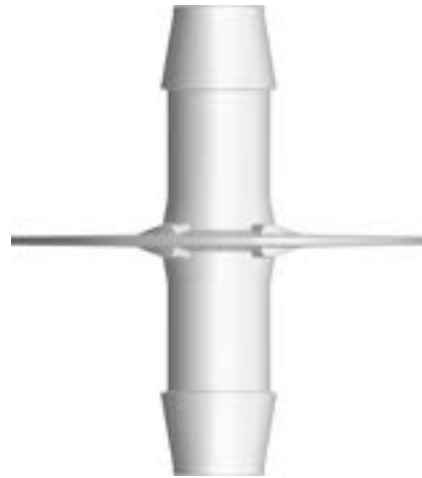

SFBP6100/6100 (-VP1) Value Pharma™ Resin

Dip Tube (Opposable Barbs) with Two 600 Series Barbs, 3/4" (19.0 mm) Tubing ID

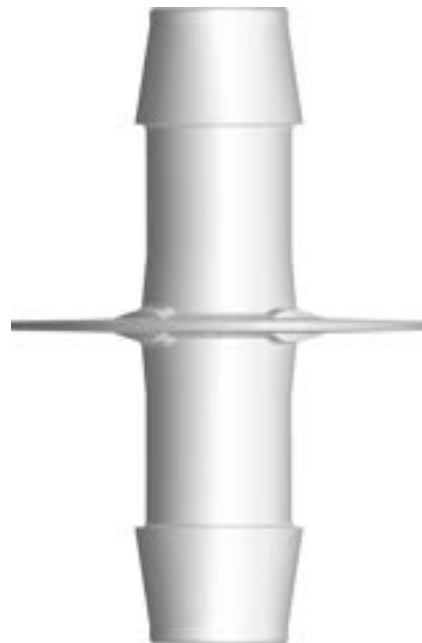

PHARMA+™

Tubing Retainers

Experience leak-free fluid transfer like never before with our advanced tubing retainers. Designed to effortlessly secure tubing over hose barbs, our patent-pending retainers feature a revolutionary lead-in ramp ensuring complete 360° compression to prevent leaks, while ribs on both edges provide an extra layer of protection. Crafted for compatibility, they work seamlessly with silicone, TPE, and PVC tubing, making them a versatile choice for biopharm processing and high-pressure medical applications. Their intuitive, clean room-molded design ensures easy, contamination-free assembly, further supported by their recyclable composition. Choose reliability, choose efficiency – choose Pharma+ Tubing Retainers and conquer fluid transfer challenges with confidence.

PHARMA+ Tubing Retainers

TR30/50-PK5

Tubing Retainer 1/4" (6.4 mm) to 7/16" (11.1 mm) OD Tubing, Polyketone



TR55/70-PK5

Tubing Retainer 3/8" (9.5 mm) to 5/8" (15.9 mm) OD Tubing, Polyketone



TR80/100-PK5 (Coming Soon)

Tubing Retainer 5/8" (15.9 mm) to 1-1/8" (28.6 mm) OD Tubing, Polyketone



Features & Benefits:

- Lead-in ramp creates complete 360° compression for leak prevention
- Intuitive design for easy assembly using existing cable tie tension tools
- Three sizes cover a range of tubing IDs and ODs
- Covering of barb edge creates a secure attachment and prevents leaks from ballooned tubing
- Clean room molded to prevent contamination
- Materials meet USP Class VI & ISO 10993 criteria
- Validated plastic material does not corrode
- Recyclable for easy disposal

Specifications:

Material:

- Polyketone (PK)

Tubing ID Sizes:

- TR30/50-PK: 1/8" (3.2 mm) to 3/16" (4.8 mm)
 - TR55/70-PK: 1/4" (6.4 mm) to 3/8" (9.5 mm)
 - TR80/100-PK: 1/2" (12.7 mm) to 3/4" (19.0 mm)
- Coming Soon

Tubing OD Sizes:

- TR30/50-PK: 1/4" (6.4 mm) to 7/16" (11.1 mm)
 - TR55/70-PK: 3/8" (9.5 mm) to 5/8" (15.9 mm)
 - TR80/100-PK: 5/8" (15.9 mm) to 1-1/8" (28.6 mm)
- Coming Soon

Sterilization:

- Gamma radiation up to 50 kGy
- Autoclavable up to 250° F (121° C)
- X-ray sterilization up to 50 kGy

Operating Pressure:

- 80 psi pressure rating to 120 psi burst

BIOClamp®

BioClamp® plastic quick-release clamps are specifically designed to meet the needs of busy pharmaceutical and bioprocessing laboratories, offering full flexibility in single-use applications. The clamp is lightweight and easy for technicians to install and provides for quick and convenient assembly release.

Features & Benefits:

- Can be SIP repeatedly
- Can be autoclaved repeatedly at 134°C for 5 minutes
- Can be subjected to 40 kiloGrays without weakening
- Reduced distortion on polymeric components
- More compatible with current manufacturing than steel
 - Greater flexibility in operation
 - Single-use disposal
- Applications
 - Bioprocessing
 - Single-use technology (SUS)
 - Drug discovery and development
 - Fluid transport
 - Pharmaceutical scale up
 - Sterile bag systems

Specifications:

Materials: Glass reinforced Nylon 66

Max. Operating Pressure: 150 psig for 1/2" to 4" clamps & 90 psig for 6" and 8" clamps

Max. Cumulative Gamma Dose: 40 kiloGrays

USP Class VI Certified Materials



Reference part shown: VNG150WHT

Due to size we are not able to display all large BioClamp® fittings. Please see www.nordsonmedical.com for part reference. Minimum package quantities vary by tube IDs, please verify minimum package sizes when placing orders.

VNG075WHT (Glass Reinforced White Nylon)

Clamp, Mini Flange, 1/2" (12.7 mm) to 3/4" (19.0 mm)

VNG150WHT (Glass Reinforced White Nylon)

Clamp, Maxi Flange, 1" (25.4 mm) to 1.5" (38.1 mm)

VNG200WHT (Glass Reinforced White Nylon)

Clamp, Maxi Flange, 2" (50.8 mm)

VNG300WHT (Glass Reinforced White Nylon)

Clamp, Maxi Flange, 3" (76.2 mm)

VNG400WHT (Glass Reinforced White Nylon)

Clamp, Maxi Flange, 4" (101.6 mm)

VNG600WH (Glass Reinforced White Nylon)

Clamp, Maxi Flange, 6" (152.4 mm)

VNG800WH (Glass Reinforced White Nylon)

Clamp, Maxi Flange, 8" (203.2 mm)

Technical Assistance

Trying to choose the correct part? Need more material information than is published in this catalog? Call Nordson MEDICAL Technical Support (970) 267-5200.

Part Drawings Online!

Nordson MEDICAL provides dimensional drawings available for download for all of its fittings.
www.nordsonmedical.com

BIOValve®

The BioValve® pinch valve is a precision restriction flow controller and shut-off valve for silicone tubing used in bioprocessing and pharmaceutical manufacturing applications.

Features & Benefits:

- Can be SIP repeatedly
- Can be autoclaved repeatedly at 134°C for 5 minutes
- Can be subjected to 40 kiloGrays without weakening
- Can be calibrated to minimize flow path turbulence
- Can be used with one hand
- Thread pitch is calibrated to 2 mm per turn

Specifications:

Materials: Glass reinforced Nylon 66

Tubing Sizes: 1/4" to 1" OD

Max. Operating Pressure: 150 psig

Max. Cumulative Gamma Dose: 40 kiloGrays

USP Class VI Certified Materials

VBV0500NW (Glass Reinforced White Nylon)
Pinch Valve Mini, 1/4" (6.4 mm) to 1/2" (12.7 mm) Tubing OD



VBV1000NW (Glass Reinforced White Nylon)
Pinch Valve, Maxi, 1/2" (12.7 mm) to 1" (25.4 mm) Tubing OD



BIOPROCESSING
FITTINGS

Looking for Something Different?

Most of our best product ideas have come from you, our customers. While we pride ourselves on our extensive product offering, we recognize that your needs are ever-changing and that our products, too, must adapt to your needs.

If there's a new product you think Nordson MEDICAL should make, please send us an Email at Orders@nordsonmedical.com describing your product concept in as much detail as you desire. We will contact you with any questions, and who knows - the next catalog edition could include products YOU told us to build.

See page 8-9 for more information on custom engineered solutions!



PHARMA Lok™

Clamps

The biopharmaceutical industry has made a strong move towards single-use technology, so Nordson MEDICAL has developed ground-breaking clamp designs that simplify the assembly process. Effortlessly and securely attach sanitary fittings to bag ports and filters with PharmaLok™ Easy-Open Clamps, and close off flow with PharmaLok™ Tube Clamps.

Nordson MEDICAL's PharmaLok™ clamps are ASME BPE compliant. Single-use and easy-open clamp sizes include .5" to .75", 1" to 1.5", 3", and 4".

PharmaLok™ clamps provide a significant advancement for the industry, as a number of existing solutions either require tools for closure or consist of multiple components, which turns what should be a simple operation into a difficult and awkward process.

Easily operated with one hand, PharmaLok's patented design allows effortless attachment of fittings to bag ports and filters. The user simply rests the fitting in the PharmaLok's regulation-sized slot, lightly grips the surrounding handles, and listens for the sound of clicks to confirm a secure connection.

Single-Use Clamps & Easy-Open Clamps

Features & Benefits:

- ASME BPE 018 DT-7-1 compliant & DIN compliant
- Easy to use, one-handed closure - no tools needed
- Repeatable use with constantly equal pressure on the gasket
- Tamper evident and zip tie compatible
- 360° compression
- Connects both plastic and stainless steel fittings
- SIP/CIP compatible
- Applications
 - Bioprocessing
 - Single-use technology (SUS)
 - Drug discovery and development
 - Fluid transport
 - Pharmaceutical scale up
 - Sterile bag systems

Specifications:

Materials:

Zytel® FGFE5171 glass-filled nylon certified to USP Class VI & ISO 10993 and available in white, blue, or orange

Temperature & Sterilization Specifications:

Normal operating temperature -94°F (-70°C) to 140°F (60°C)

Cryogenic freezing to -112°F (-80°C)

Autoclavable up to 273°F (134°C) for a maximum of 30 min.

Gamma radiation up to 50 kGy

X-ray sterilization up to 50 kGy

Maximum Pressure:

80 psi (conforms to ASME BPE-2014 PM-4.2.2)

Sizes:

Fitting .5" (12.7 mm) to .75" (19.0 mm), 1" (25.4 mm) to 1.5" (31.8 mm), 3" (76.2 mm), and 4" (101.6 mm)

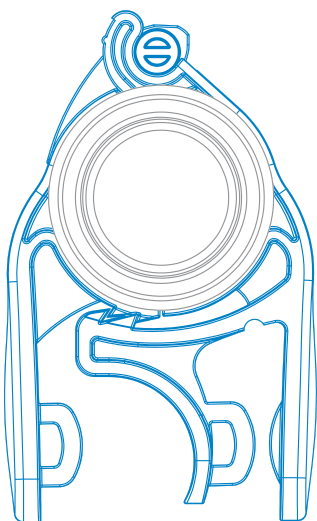

**Easy,
2 Click
Closure**

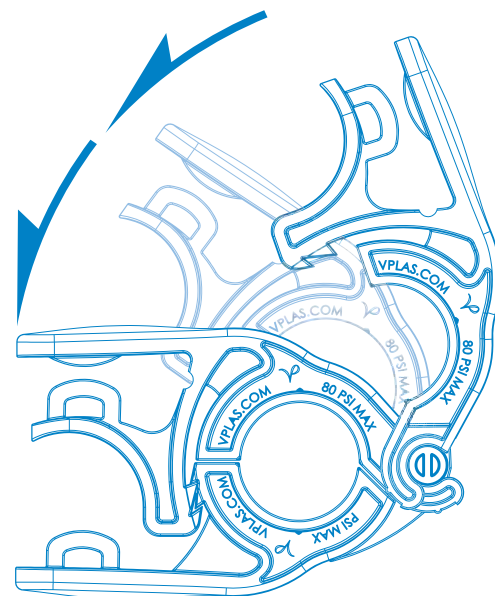

360° Compression

PHARMALOK SERIES:
Easy-Open Clamps

CPAX150 (-U71)

PharmaLok™ Easy-Open Clamp Series, Hygienic Union TC Version
1" (25.4 mm) to 1.5" (38.1 mm)

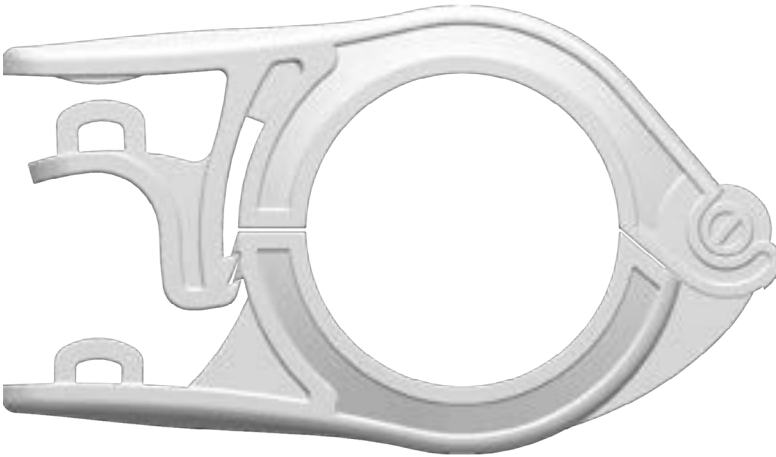

CPAN75 (-U71)

PharmaLok™ Easy-Open Clamp Series, Hygienic Union TC Version
.5" (12.7 mm) to .75" (19.0 mm)



CPAX150 (-U75)

PharmaLok™ Easy-Open Clamp Series, Hygienic Union TC Version
1" (25.4 mm) to 1.5" (38.1 mm), Glass Reinforced Blue Nylon



CPAN75 (-U75)

PharmaLok™ Easy-Open Clamp Series, Hygienic Union TC Version
.5" (12.7 mm) to .75" (19.0 mm), Glass Reinforced Blue Nylon



CPAX150 (-U706)

PharmaLok™ Easy-Open Clamp Series, Hygienic Union TC Version
1" (25.4 mm) to 1.5" (38.1 mm), Glass Reinforced Orange Nylon



CPAN75 (-U706)

PharmaLok™ Easy-Open Clamp Series, Hygienic Union TC Version
.5" (12.7 mm) to .75" (19.0 mm), Glass Reinforced Orange Nylon



BIOPROCESSING
FITTINGS

PHARMALOK SERIES: Easy-Open Clamps

CPAX300 (-U71)

PharmaLok™ Easy-Open Clamp Series, Hygienic Union TC Version 3" (76.2 mm), Glass Reinforced White Nylon

CPAX400 (-U71)

PharmaLok™ Easy-Open Clamp Series, Hygienic Union TC Version 4" (101.6 mm), Glass Reinforced White Nylon



PHARMALOK SERIES: Single-Use Clamps

CPX150 (-U71)

Single-Use Series Clamp, TC Version 1" (25.4 mm) to 1.5" (38.1 mm)

CPN75 (-U71)

Single-Use Series Clamp, TC Version .5" (12.7 mm) to .75" (19.0 mm)

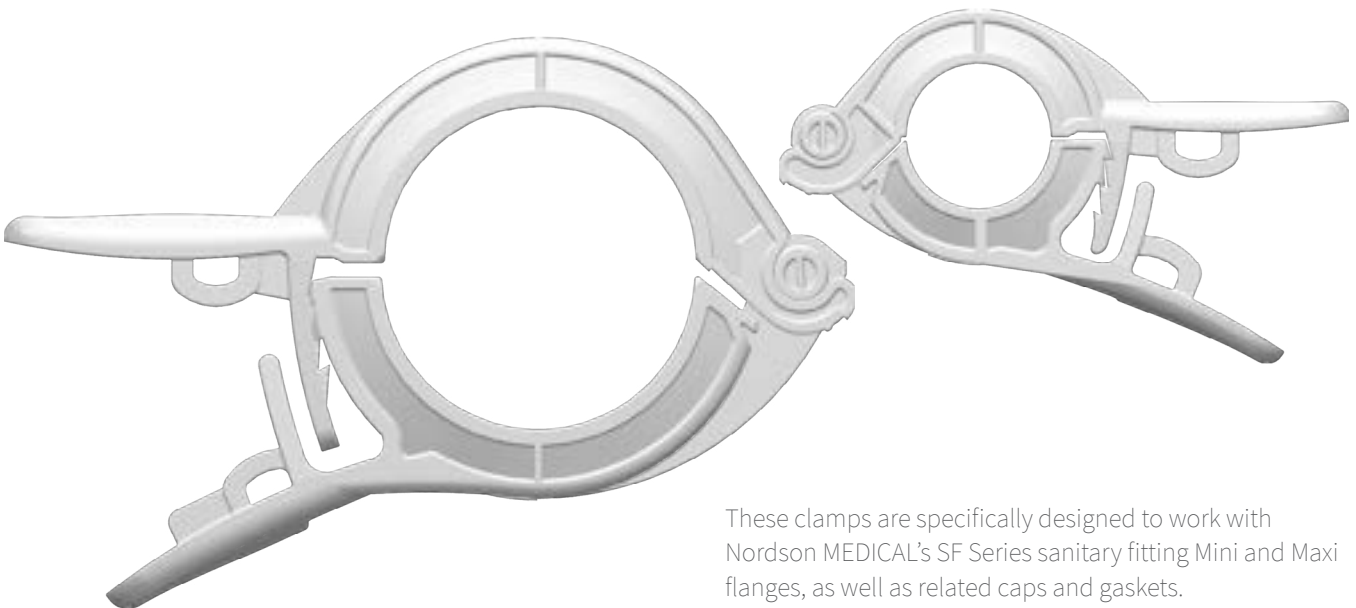

These clamps are specifically designed to work with Nordson MEDICAL's SF Series sanitary fitting Mini and Maxi flanges, as well as related caps and gaskets.

TUBE

Clamps

Features & Benefits:

- Designed for use with silicone and TPE tubing
- Easy to use, one-handed closure - no tools needed
- Tamper evident and zip tie compatible

Specifications:

Materials: Zytel® FGFE5171 glass-filled nylon certified to USP Class VI & ISO 10993 and available in white

Temperature & Sterilization Specifications:

Normal operating temperature -94°F (-70°C) to 140°F (60°C)

Cryogenic freezing to -112°F (-80°C)

Autoclavable up to 273°F (134°C) for a maximum of 30 min.

Gamma radiation up to 50 kGy

X-ray sterilization up to 50 kGy

Maximum Pressure: Up to 150 psi

Thin-Walled Tube Clamp Size: Wall thickness 1/32" (0.79 mm) to 3/32" (2.38 mm), Max OD 1/2" (12.7 mm)

Standard Tube Clamp Size: Wall thickness 1/8" (3.2 mm) to 1/4" (6.4 mm), Max OD 1" (25.4 mm)

Large Tube Clamp Size: Wall thickness 1/8" (3.2 mm) to 1/4" (6.4 mm), Max OD 2.5" (63.5 mm)

CPT90 (-U71 -U706)

PharmaLok™ Small and Thin-Walled Tube Clamp, Wall Thickness 1/32" (0.79 mm) to 3/32" (2.4 mm), Max OD 1/2" (12.7 mm), Glass-Filled White Nylon



CPT100 (-U71 -U706)

PharmaLok™ Standard Tube Clamp, Wall Thickness 1/8" (3.2 mm) to 1/4" (6.4 mm), Max OD 1" (25.4 mm), Glass-Filled White Nylon



CPT110 (-U71 -U706)

PharmaLok™ Large Tube Clamp, Wall Thickness 1/8" (3.2 mm) to 1/4" (6.4 mm), Max OD 2.5" (63.5 mm), Glass-Filled White Nylon



SPAULDING™

Aseptic Disconnects

Providing a leak-free connection, the Spaulding™ Series Aseptic Disconnects eliminate the need for pinch clamps and tube welders. Smooth disconnects are achievable with the easy-to-use design, and valuable fluids are protected by valves that automatically shut off flow when the fittings are disconnected. Available in USP Class VI, ADCF Polysulfone, validation and test results confirm their suitability in pre-sterilized systems and are also gamma radiation stable. These connectors are interchangeable with similar plastic connectors.

Features & Benefits:

- Valves that automatically shut off flow at disconnection
- Interchangeable with other plastic & metal connectors
- Plugs and caps available to maintain fluid path integrity
- Made with BSE/TSE-free materials
- Validation and test results confirm their suitability in pre-sterilized systems
- Materials satisfy USP Class VI criteria
- Fittings meet industry requirements
- Aseptic disconnect operation

Specifications:

- **Materials:** Body - USP Class VI, ADCF tinted polysulfone, o-rings - platinum-cured silicone, springs - 316 stainless steel
- **Sterilization:** Gamma radiation stable up to 50kGy, autoclavable to 270°F (132°C) for a maximum of 60 minutes
- **Fits Tubing IDs:** 1/4" (6.4 mm), 3/8" (9.5 mm), 1/2" (12.7 mm)
- **Operating Temperature:** -40°F (-40°C) to 280°F (138°C)
- **Leak Resistance:** 125 psi (8.62 bar)

SDAVF655NPS (-001)

Spaulding™ Aseptic Disconnect, Female Valved Connector, 600 Series Barb, 1/4" (6.4 mm) ID Tubing, Animal-Free Polysulfone, Silicone O-Ring



SDAM655NPS (-001)

Spaulding™ Aseptic Disconnect, Male Open Flow Connector, 600 Series Barb, 1/4" (6.4 mm) ID Tubing, Animal-Free Polysulfone, Silicone O-Ring



SDAVM655NPS (-001)

Spaulding™ Aseptic Disconnect, Male Valved Connector, 600 Series Barb, 1/4" (6.4 mm) ID Tubing, Animal-Free Polysulfone, Silicone O-Ring



Need More Details?

Part drawings, minimum order quantities, and CAD requests can be found online. Visit www.nordsonmedical.com or contact Sales at Orders@nordsonmedical.com.

Need it Fast?

You can order our parts online now with no order \$ minimums, 24 hours a day, 7 days a week!
www.nordsonmedical.com

SPAULDING SERIES: Aseptic Disconnects

SDAVF670NPS (-001)

Spaulding™ Aseptic Disconnect, Female Valved Connector, 600 Series Barb, 3/8" (9.5 mm) ID Tubing, Animal-Free Polysulfone, Silicone O-Ring



SDAVF680NPS (-001)

Spaulding™ Aseptic Disconnect, Female Valved Connector, 600 Series Barb, 1/2" (12.7 mm) ID Tubing, Animal-Free Polysulfone, Silicone O-Ring



SDAM670NPS (-001)

Spaulding™ Aseptic Disconnect, Male Open Flow Connector, 600 Series Barb, 3/8" (9.5 mm) ID Tubing, Animal-Free Polysulfone, Silicone O-Ring



SDAM680NPS (-001)

Spaulding™ Aseptic Disconnect, Male Open Flow Connector, 600 Series Barb, 1/2" (12.7 mm) ID Tubing, Animal-Free Polysulfone, Silicone O-Ring

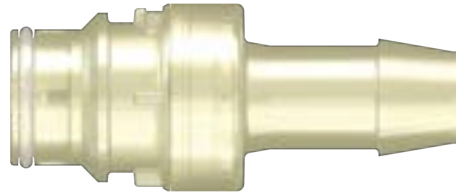

SDAVM670NPS (-001)

Spaulding™ Aseptic Disconnect, Male Valved Connector, 600 Series Barb, 3/8" (9.5 mm) ID Tubing, Animal-Free Polysulfone, Silicone O-Ring

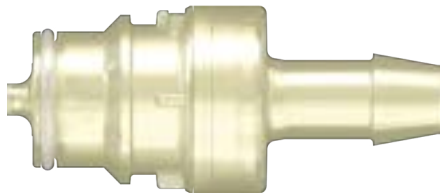

SDAVM680NPS (-001)

Spaulding™ Aseptic Disconnect, Male Valved Connector, 600 Series Barb, 1/2" (12.7 mm) ID Tubing, Animal-Free Polysulfone, Silicone O-Ring



BIOPROCESSING
FITTINGS

SDAFCNPS (-001)

Spaulding™ Aseptic Disconnect, Female Cap Connector, Animal-Free Polysulfone, Silicone O-Ring



SDAMPNPS (-001)

Spaulding™ Aseptic Disconnect, Male Plug Connector, Animal-Free Polysulfone, Silicone O-Ring



Did You Know?

Nordson MEDICAL has an interactive PDF available online at www.nordsonmedical.com. Access part drawings, reference charts, data sheets, and more from just one location!

Technical Assistance

Trying to choose the correct part? Need more material information than is published in this catalog? Call Nordson MEDICAL Technical Support (970) 267-5200.

CYLINDRAFlow™

Manifolds

Nordson MEDICAL is proud to introduce the first all-in-one manifold for pharmaceutical and single-use biopharmaceutical fluid transfer applications. The revolutionary design of this patent-pending, compact fitting not only saves space, but also simplifies use and assembly. With five ports available in one component, gone are the many leak points found in traditional stopcock and Y connector manifolds. Ideal for downstream processing, multiple bags can easily be filled from one large bag. Flow is consistent as it travels around the inner body of the part, maintaining a steady pressure. The large flow selector is effortless to turn, and the lock-in-place feature gives you assurance that you are utilizing the desired port.

CYLINDRAFLOW: Manifolds

FMD5P670-001

CYLINDRAFlow™ Manifold Director, 600 Series Barbs, 3/8" (9.5 mm) Flow, 1 Input, 5 Outputs, 15 psi Liquid Rated, -9024 Polycarbonate Material

Features & Benefits:

- Can accommodate up to 5 fluid lines
- Flow restricted to one port at a time
- No pressure drop as fluid moves around & through the ports
- Intuitive push-to-turn flow selector
- Easier to use and fewer leak points than stopcock and Y connector manifolds
- Materials meet USP Class VI & ISO 10993 criteria
- Gamma radiation stable
- Can be daisy chained for additional ports
- Arrows to provide a clear indication of how to turn the flow selector and which port is in use
- Etched data code for easy access to product resources and material information

Specifications:

Materials: Body & flow selector - gamma stable polycarbonate, internal spring - 316 stainless steel, gasket - platinum-cured silicone

Maximum Pressure: 15psi (1.0 bar) liquid rated

Fits Tubing IDs: 3/8" (9.5 mm)

Barb Size: 600 series

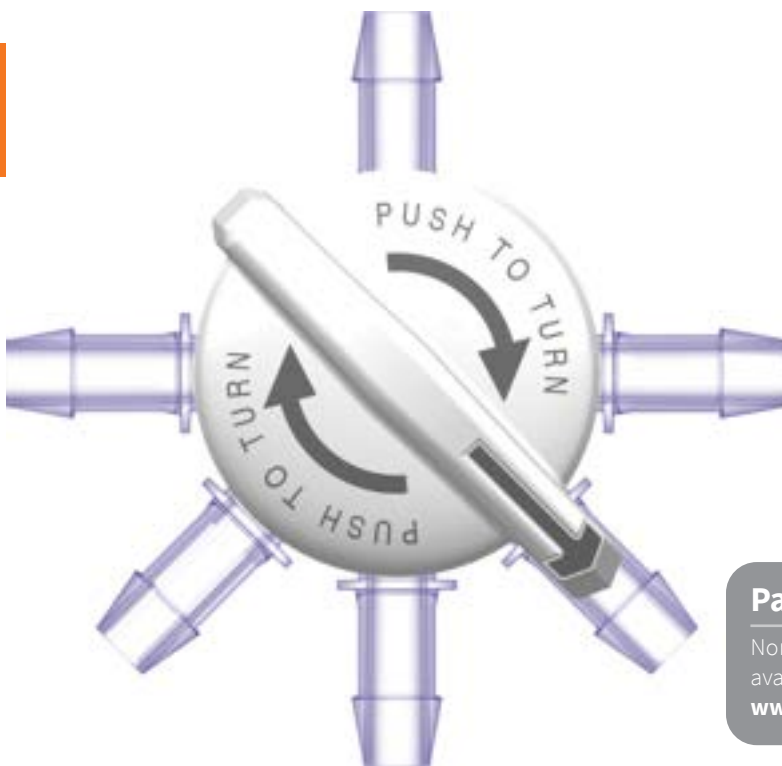

Part Drawings Online!

Nordson MEDICAL provides dimensional drawings available for download for all of its fittings.
www.nordsonmedical.com

Need Samples for Evaluation?

You can call to request most of our standard product in quantities of 5, or less, for free application evaluation.
+1 (970) 267-5200 Toll Free: (888) 404-5837

SF Series

Sanitary Fittings

The SF Series sanitary fittings are based on design concepts calling for a heavy-duty part with superior side load strength, while providing superior flow-through characteristics, making them the connectors of choice for single-use bioprocesses. Pharmaceutical professionals find these plastic fittings offer all the benefits of disposable parts while offering performance capabilities not found in earlier versions of flanged fittings.

Features & Benefits:

- Animal-free materials: No BSE documentation required
- Radiused flow surfaces: Smooth uninterrupted flow
- “Mini” & “Maxi” sizes: Easy to retrofit current operations, works with commercially available biopharm clamps
- No Particulate build-up: Interior surface controlled to 15 Ra microinch
- Reducer sizes available

Specifications:

Materials: Animal-Free Polypropylene, Natural PVDF

Tubing ID Sizes:

- 1/8, 1/4, 3/8, 1/2, 3/4, 1, 1-1/2, 2"
- Reducers 1" x 3/4", 1-1/2" x 3/4", 1-1/2" x 1", 2" x 3/4", 2" x 1-1/2"

Leak Resistance: Tested at 80 psi air under water for 90 seconds with no leaks

Tubing Removal Force:

- 1/4" PP with C-Flex® shore A tubing: 21 lbs.
- 1/2" PP with C-Flex® shore A tubing: 89 lbs.
- 1" PP with C-Flex® shore A tubing: 121 lbs.

Interior Surface Finish: 15 Ra Microinch

SFMN630 (-6005)

Sanitary Fitting, Mini Flange 3/4" to 600 Series Barb, 1/8" (3.2 mm) Tubing ID

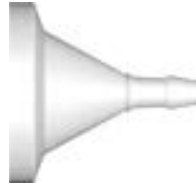

SFMN655 (-6005 -J2A)

Sanitary Fitting, Mini Flange 3/4" to 600 Series Barb, 1/4" (6.4 mm) Tubing ID



SFMN670 (-6005 -J2A)

Sanitary Fitting, Mini Flange 3/4" to 600 Series Barb, 3/8" (9.5 mm) Tubing ID



SFMN680 (-6005 -J2A)

Sanitary Fitting, Mini Flange 3/4" to 600 Series Barb, 1/2" (12.7 mm) Tubing ID



SFMN6100 (-6005 -J2A)

Sanitary Fitting, Mini Flange 3/4" to 600 Series Barb, 3/4" (19.0 mm) Tubing ID



SANITARY FITTINGS:
Maxi Flange

SFMX655 (-6005 -J2A)

Sanitary Fitting, Maxi Flange 1-1/2" to 600 Series Barb, 1/4" (6.4 mm) Tubing ID



SFMX6110 (-6005 -J2A)

Sanitary Fitting, Maxi Flange 1-1/2" to 600 Series Barb, 1.0" (25.4 mm) Tubing ID



SFMX670 (-6005 -J2A)

Sanitary Fitting, Maxi Flange 1-1/2" to 600 Series Barb, 3/8" (9.5 mm) Tubing ID



SFMX6150 (-6005)

Sanitary Fitting, Maxi Flange 1.5" to 600 Series Barb, 1.5" (38.1 mm) Tubing ID

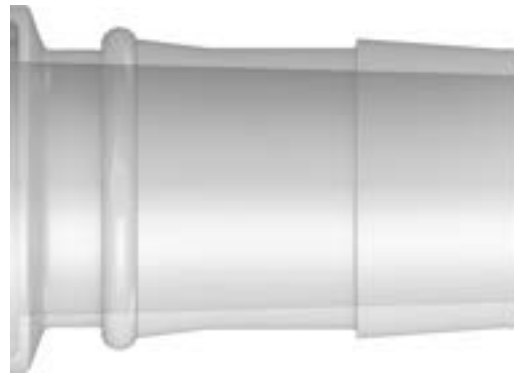

SFMX680 (-6005 -J2A)

Sanitary Fitting, Maxi Flange 1-1/2" to 600 Series Barb, 1/2" (12.7 mm) Tubing ID



SFM2X6110 (-6005)

Sanitary Fitting, Maxi Flange 2.0" to 600 Series Barb, 1.0" (25.4 mm) Tubing ID

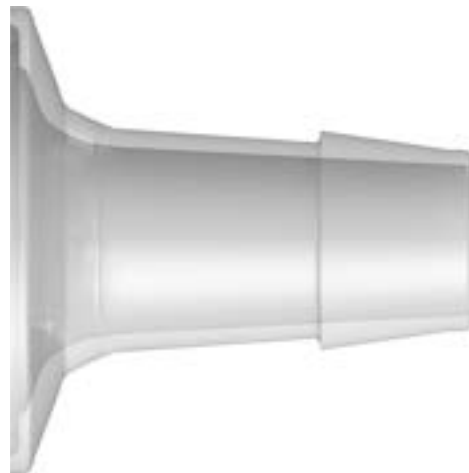

SFMX6100 (-6005 -J2A)

Sanitary Fitting, Maxi Flange 1-1/2" to 600 Series Barb, 3/4" (19.0 mm) Tubing ID



SANITARY FITTINGS:
Maxi Flange

SFM2X6150 (-6005)

Sanitary Fitting, Maxi Flange 2.0" to 600 Series Barb, 1.5" (38.1 mm) Tubing ID

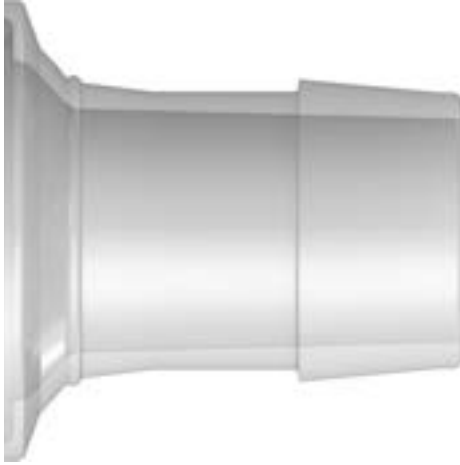

SFM3X6110 (-6005)

Sanitary Fitting, Maxi Flange 3.0" to 600 Series Barb, 1.0" (25.4 mm) Tubing ID

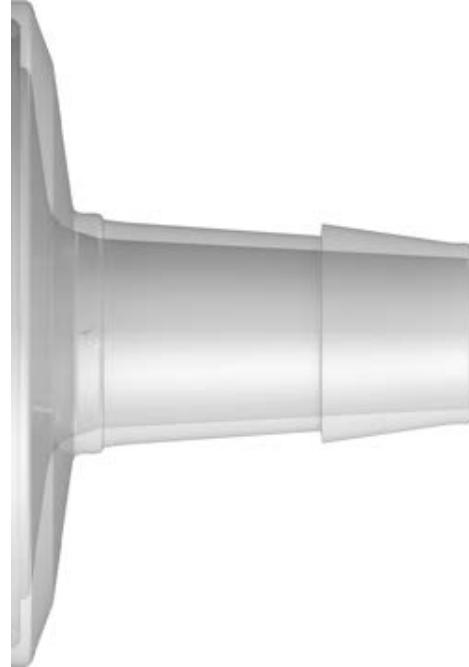

SFM2XY (-6005)

Sanitary Fitting, Y Maxi Flange 2.0" x 2.0" x 2.0" (50.8 mm) Tubing ID

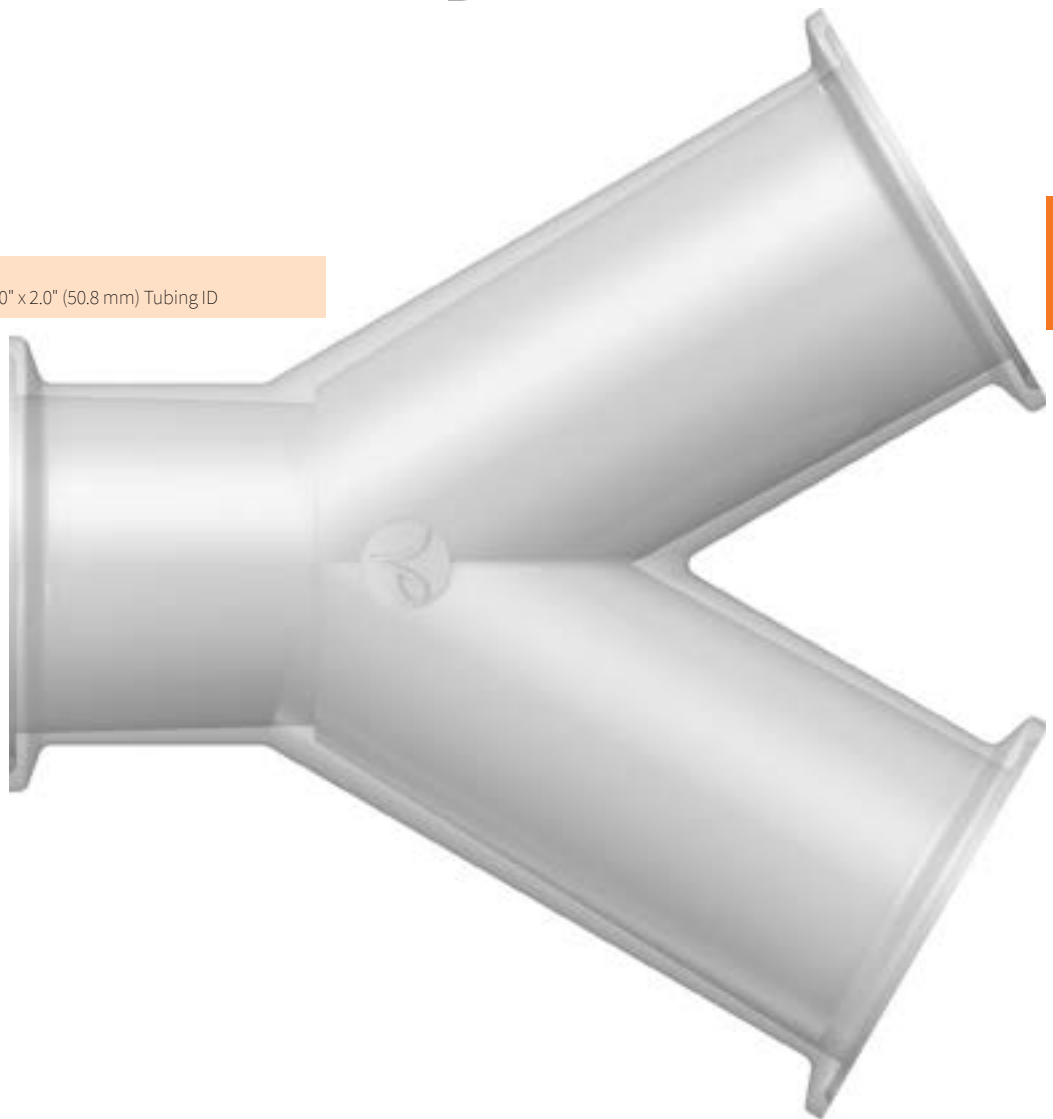

BIOPROCESSING
FITTINGS

SANITARY FITTINGS:
Caps

SFMNC (-6005 -J2A)

Sanitary Fitting Mini Cap 3/4"



SFMXC (-6005 -J2A)

Sanitary Fitting Maxi Cap 1-1/2"



SFM2XC (-6005)

Sanitary Fitting Maxi Cap 2.0"



SFM3XC (-6005)

Sanitary Fitting Maxi Cap 3.0"



SANITARY FITTINGS:
TC Reducers

SFM100/SFM075 (-6005)

Sanitary Fitting, Concentric Reducer 1" (25.4 mm) Landish TC x .75" (19.0 mm) TC



SFM150/SFM075 (-6005)

Sanitary Fitting, Concentric Reducer 1.5" (38.1 mm) Landish TC x .75" (19.0 mm) TC



SANITARY FITTINGS:
TC Reducers

SFM150/SFM100 (-6005)

Sanitary Fitting, Concentric Reducer 1.5" (38.1 mm) Landish TC x 1" (25.4 mm) TC



SFM200/SFM075 (-6005)

Sanitary Fitting, Concentric Reducer 2" (50.8 mm) Landish TC x .75" (19.0 mm) TC



SFM200/SFM150 (-6005)

Sanitary Fitting, Concentric Reducer 2" (50.8 mm) Landish TC x 1.5" (38.1 mm) TC



GASKETS: Mini and Maxi Flange Accessories

GASKETS

Material options include Class VI compliant PTFE/EPDM and platinum-cured silicone in gasket sizes that fit both the 1-½" (Maxi) and the ¾" (Mini) Flange Series. Keeping customer requirements in mind, these components were manufactured for applications requiring the highest sanitary standards and chemical purity.

GMN450 (-PX) Platinum-Cured Silicone

Molded Gasket for Mini Flange SFMN Series Fittings



GMX455 (-PX) Platinum-Cured Silicone

Molded Gasket for Maxi Flange SFMX Series Fittings



GMN75 (-PX) Platinum-Cured Silicone

Molded Gasket for Mini Flange SFMN Series Fittings



GMX150 (-PX) Platinum-Cured Silicone

Molded Gasket for Maxi Flange SFMX Series Fittings



G40MPGR-TF150 (-E) PTFE

Molded Tuf-Flex® Gasket for Maxi Flange SFMX Series Fittings



G424TRX-0300 Platinum-Cured Silicone

Molded Gasket for 3" Flange Fittings



BIOPROCESSING
FITTINGS

Did You Know?

Nordson MEDICAL has an interactive PDF available online at www.nordsonmedical.com. Access part drawings, reference charts, data sheets, and more from just one location!

Custom Assembly

We produce standard components to fit your current assemblies and devices, but we also provide custom solutions by applying a variety of assembly options, such as joining fittings, connectors, filters, and other components to tubing. From systems using a single fitting to complex configurations utilizing various components, we can design complete assemblies to your requirements.

GASKETS:
Mini and Maxi Flange Accessories

GM4749TRX-0600 Platinum-Cured Silicone
Molded Gasket for 6" Flange Fittings



GASKETS:
Platinum-Cured Silicone Gaskets

G40RX-PX-0400 Platinum-Cured Silicone
Molded Gasket, 4"

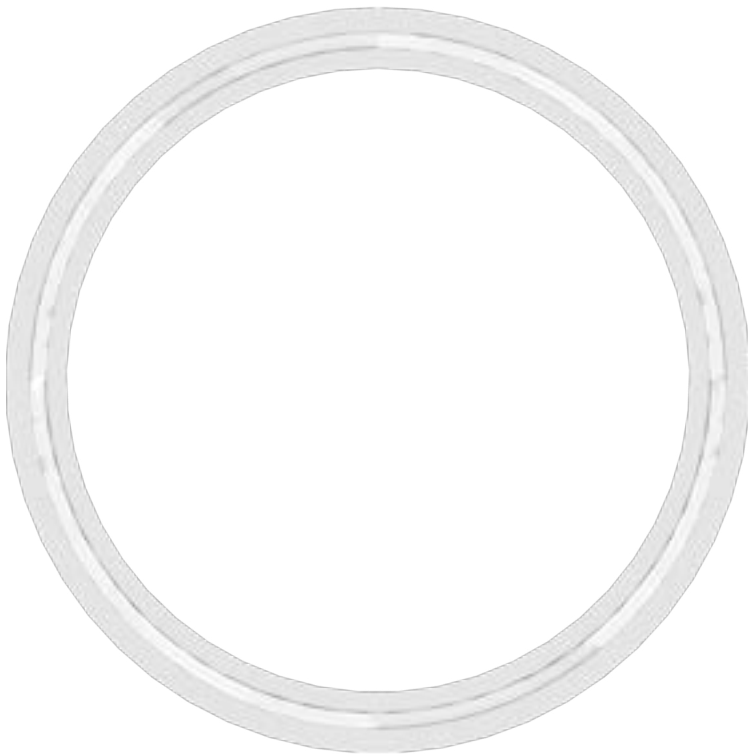

BIOPROCESSING
FITTINGS

LARGE TUBE

Fittings

Nordson MEDICAL offers barbed tube fittings and tubing connectors in sizes ranging from 1/16" (1.6 mm) to 1.5" (38.1 mm) tubing ID in over 100 separate configurations in nylon, polypropylene, polycarbonate and PVDF, with other engineering resins available on special order. Available barbed fitting styles include straight tube connectors, elbow fittings, tee fittings, crosses, Y (wye) connectors, multi-port connectors, and multiple straight, elbow and tee reducer combinations.

LARGE TUBE FITTINGS: Straight Through



Reference part shown: **N670**

Due to size we are not able to display all large tube fittings. Please see www.nordsonmedical.com for part reference. Minimum package quantities vary by tube IDs, please verify minimum package sizes when placing orders.

N070 (-6005)
Straight Through Connector with 500 Series Barbs, 3/8" (9.5 mm) ID Tubing

N670 (-6005 -9 -J2A)
Straight Through Connector with 600 Series Barbs, 3/8" (9.5 mm) ID Tubing

N080 (-6005)
Straight Through Connector with 500 Series Barbs, 1/2" (12.7 mm) ID Tubing

N680 (-6005 -J2A)
Straight Through Connector with 600 Series Barbs, 1/2" (12.7 mm) ID Tubing

N090 (-0)
Straight Through Connector with 500 Series Barbs, 5/8" (16.0 mm) ID Tubing

N690 (-0)
Straight Through Connector with 600 Series Barbs, 5/8" (16.0 mm) ID Tubing

N100 (-6005)
Straight Through Connector with 500 Series Barbs, 3/4" (19.0 mm) ID Tubing

N6100 (-6005)
Straight Through Connector with 600 Series Barbs, 3/4" (19.0 mm) ID Tubing

N110 (-0)
Straight Through Connector with 500 Series Barbs, 1" (25.4 mm) ID Tubing

N6110 (-6005)
Straight Through Connector with 600 Series Barbs, 1" (25.4 mm) ID Tubing

N6150 (-6005)
Straight Through Connector with 600 Series Barbs, 1.5" (38.1 mm) ID Tubing



Reference part shown: **N070/013**

Due to size we are not able to display all large tube fittings. Please see www.nordsonmedical.com for part reference. Minimum package quantities vary by tube IDs, please verify minimum package sizes when placing orders.

N070/013 (-6005)
Straight Through Reduction Connector with 500 Series Barbs, 3/8" (9.5 mm) and 1/8" (3.2 mm) ID Tubing

N670/630 (-6005)
Straight Through Reduction Connector with 600 Series Barbs, 3/8" (9.5 mm) and 1/8" (3.2 mm) ID Tubing

N070/055 (-0 -6005 -9)
Straight Through Reduction Connector with 500 Series Barbs, 3/8" (9.5 mm) and 1/4" (6.4 mm) ID Tubing

N670/655 (-6005 -9)
Straight Through Reduction Connector with 600 Series Barbs, 3/8" (9.5 mm) and 1/4" (6.4 mm) ID Tubing

N080/055 (-0 -6005)
Straight Through Reduction Connector with 500 Series Barbs, 1/2" (12.7 mm) and 1/4" (6.4 mm) ID Tubing

N680/655 (-6005 -J2A)
Straight Through Reduction Connector with 600 Series Barbs, 1/2" (12.7 mm) and 1/4" (6.4 mm) ID Tubing

N080/070 (-0 -6005)
Straight Through Reduction Connector with 500 Series Barbs, 1/2" (12.7 mm) and 3/8" (9.5 mm) ID Tubing

N680/670 (-6005)
Straight Through Reduction Connector with 600 Series Barbs, 1/2" (12.7 mm) and 3/8" (9.5 mm) ID Tubing

N090/055 (-0)
Straight Through Reduction Connector with 500 Series Barbs, 5/8" (16.0 mm) and 1/4" (6.4 mm) ID Tubing

N690/655 (-6005)
Straight Through Reduction Connector with 600 Series Barbs, 5/8" (16.0 mm) and 1/4" (6.4 mm) ID Tubing

N090/070 (-0)
Straight Through Reduction Connector with 500 Series Barbs, 5/8" (16.0 mm) and 3/8" (9.5 mm) ID Tubing

N6100/670 (-6005)
Straight Through Reduction Connector with 600 Series Barbs, 3/4" (19 mm) and 3/8" (9.5 mm) ID Tubing

N100/080 (-0 -6005)
Straight Through Reduction Connector with 500 Series Barbs, 3/4" (19.0 mm) and 1/2" (12.7 mm) ID Tubing

N6100/680 (-6005)
Straight Through Reduction Connector with 600 Series Barbs, 3/4" (19 mm) and 1/2" (12.7 mm) ID Tubing

N6110/680 (-6005)
Straight Through Reduction Connector with 600 Series Barbs, 1" (25.4 mm) and 1/2" (12.7 mm) ID Tubing

N110/100 (-0)
Straight Through Reduction Connector with 500 Series Barbs, 1" (25.4 mm) and 3/4" (19.0 mm) ID Tubing

N6110/6100 (-6005)
Straight Through Reduction Connector with 600 Series Barbs, 1" (25.4 mm) and 3/4" (19.0 mm) ID Tubing

N6150/6110 (-6005)
Straight Through Reduction Connector with 600 Series Barbs, 1.5" (38.1 mm) and 1" (25.4 mm) ID Tubing

Reference part shown: L070

Due to size we are not able to display all large tube fittings. Please see www.nordsonmedical.com for part reference. Minimum package quantities vary by tube IDs, please verify minimum package sizes when placing orders.

L070 (-6005)

Elbow Connector with 500 Series Barbs, 3/8" (9.5 mm) ID Tubing

L080 (-0 -6005)

Elbow Connector with 500 Series Barbs, 1/2" (12.7 mm) ID Tubing

L090 (-0)

Elbow Connector with 500 Series Barbs, 5/8" (16.0 mm) ID Tubing

L100 (-0 -6005)

Elbow Connector with 500 Series Barbs, 3/4" (19.0 mm) ID Tubing

L110 (-0 -6005)

Elbow Connector with 500 Series Barbs, 1" (25.4 mm) ID Tubing

L6110 (-6005)

Elbow Connector with 600 Series Barbs, 1" (25.4 mm) ID Tubing

CF494 (-6005)

Low-profile Elbow Connector with Custom 600 Series Barbs, 1" (25.4 mm) ID Tubing

Reference part shown: L070/055

Due to size we are not able to display all large tube fittings. Please see www.nordsonmedical.com for part reference. Minimum package quantities vary by tube IDs, please verify minimum package sizes when placing orders.

L070/055 (-0 -6005)

Elbow Reduction Connector with 500 Series Barbs, 3/8" (9.5 mm) and 1/4" (6.4 mm) ID Tubing

L080/070 (-0)

Elbow Reduction Connector with 500 Series Barbs, 1/2" (12.7 mm) and 3/8" (9.5 mm) ID Tubing

L100/080 (-0)

Elbow Reduction Connector with 500 Series Barbs, 3/4" (19.0 mm) and 1/2" (12.7 mm) ID Tubing

L110/100 (-0)

Elbow Reduction Connector with 500 Series Barbs, 1" (25.4 mm) and 3/4" (19.0 mm) ID Tubing

Need More Details?

Part drawings, minimum order quantities, and CAD requests can be found online. Visit www.nordsonmedical.com or contact Sales at Orders@nordsonmedical.com.

Need Smaller Fittings?

You can find tube fittings for up to 5/16" (8.0 mm) ID tubing in our selection of Tube Fittings beginning on [page 20](#) and online at www.nordsonmedical.com.

Technical Assistance

Trying to choose the correct part? Need more material information than is published in this catalog? Call Nordson MEDICAL Technical Support **(970) 267-5200**.



Reference part shown: T070

Due to size we are not able to display all large tube fittings. Please see www.nordsonmedical.com for part reference. Minimum package quantities vary by tube IDs, please verify minimum package sizes when placing orders.

T070 (-6005 -9)

Tee Connector with 500 Series Barbs, 3/8" (9.5 mm) ID Tubing

T670 (-1 -6005)

Tee Connector with 600 Series Barbs, 3/8" (9.5 mm) ID Tubing

T080 (-0 -6005)

Tee Connector with 500 Series Barbs, 1/2" (12.7 mm) ID Tubing

T680 (-6005 -J2A)

Tee Connector with 600 Series Barbs, 1/2" (12.7 mm) ID Tubing

T690 (-6005)

Tee Connector with 600 Series Barbs, 5/8" (16.0 mm) ID Tubing

T100 (-6005)

Tee Connector with 500 Series Barbs, 3/4" (19.0 mm) ID Tubing

T6100 (-6005)

Tee Connector with 600 Series Barbs, 3/4" (19.0 mm) ID Tubing

T110 (-0)

Tee Connector with 500 Series Barbs, 1" (25.4 mm) ID Tubing

T6110 (-6005)

Tee Connector with 600 Series Barbs, 1" (25.4 mm) ID Tubing

T6150 (-6005)

Tee Connector with 600 Series Barbs, 1.5" (38.1 mm) ID Tubing

Need Smaller Fittings?

You can find tube fittings for up to 5/16" (8.0 mm) ID tubing in our selection of Tube Fittings beginning on [page 20](#) and online at www.nordsonmedical.com.



Reference part shown: T070/055

Due to size we are not able to display all large tube fittings. Please see www.nordsonmedical.com for part reference. Minimum package quantities vary by tube IDs, please verify minimum package sizes when placing orders.

T070/055 (-0 -6005 -9)

Tee Reduction Connector with 500 Series Barbs, 3/8" (9.5 mm) and 1/4" (6.4 mm) ID Tubing

T080/055 (-0 -6005)

Tee Reduction Connector with 500 Series Barbs, 1/2" (12.7 mm) and 1/4" (6.4 mm) ID Tubing

T080/070 (-6005)

Tee Reduction Connector with 500 Series Barbs, 1/2" (12.7 mm) and 3/8" (9.5 mm) ID Tubing

T100/080 (-0 -6005 -9)

Tee Reduction Connector with 500 Series Barbs, 3/4" (19.0 mm) and 1/2" (12.7 mm) ID Tubing

T110/100 (-0 -6005)

Tee Reduction Connector with 500 Series Barbs, 1" (25.4 mm) and 3/4" (19.0 mm) ID Tubing

T670/655 (-6005)

Tee Reduction Connector with 600 Series Barbs, 3/8" x 2 (9.5 mm) and 1/4" (6.4 mm) ID Tubing

T680/655 (-6005)

Tee Reduction Connector with 600 Series Barbs, 1/2" x 2 (12.7 mm) and 1/4" (6.4 mm) ID Tubing

T680/670 (-6005)

Tee Reduction Connector with 600 Series Barbs, 1/2" x 2 (12.7 mm) and 3/8" (9.5 mm) ID Tubing

T6100/670 (-6005)

Tee Reduction Connector with 600 Series Barbs, 3/4" x 2 (19.0 mm) and 3/8" (9.5 mm) ID Tubing

T6100/680 (-6005)

Tee Reduction Connector with 600 Series Barbs, 3/4" x 2 (19.0 mm) and 1/2" (12.7 mm) ID Tubing

T6110/6100 (-6005)

Tee Reduction Connector with 600 Series Barbs, 1" x 2 (25.4 mm) and 3/4" (19.0 mm) ID Tubing

T6150/6100 (-6005)

Tee Reduction Connector with 600 Series Barbs, 1.5" x 2 (38.1 mm) and 3/4" (19.0 mm) ID Tubing

T6150/6110 (-6005)

Tee Reduction Connector with 600 Series Barbs, 1.5" x 2 (38.1 mm) and 1" (25.4 mm) ID Tubing



Reference part shown: Y070

Due to size we are not able to display all large tube fittings. Please see www.nordsonmedical.com for part reference. Minimum package quantities vary by tube IDs, please verify minimum package sizes when placing orders.

Y070 (-6005)

Y Connector with 500 Series Barbs, 3/8" (9.5 mm) ID Tubing

Y670 (-6005 -9 -J2A)

Y Connector with 600 Series Barbs, 3/8" (9.5 mm) ID Tubing

Y080 (-0 -6005)

Y Connector with 500 Series Barbs, 1/2" (12.7 mm) ID Tubing

Y680 (-6005 -J2A)

Y Connector with 600 Series Barbs, 1/2" (12.7 mm) ID Tubing

Y090 (-0 -6005 -J2A)

Y Connector with 500 Series Barbs, 5/8" (16.0 mm) ID Tubing

Y690 (-6005)

Y Connector with 600 Series Barbs, 5/8" (16.0 mm) ID Tubing

Y100 (-0 -6005 -J2A)

Y Connector with 500 Series Barbs, 3/4" (19.0 mm) ID Tubing

Y6100 (-6005)

Y Connector with 600 Series Barbs, 3/4" (19.0 mm) ID Tubing

Y110 (-6005)

Y Connector with 500 Series Barbs, 1" (25.4 mm) ID Tubing

Y6110 (-6005)

Y Connector with 600 Series Barbs, 1" (25.4 mm) ID Tubing

Y6150 (-6005)

Y Connector with 600 Series Barbs, 1.5" (38.1 mm) ID Tubing



Reference part shown: Y655/670

Due to size we are not able to display all large tube fittings. Please see www.nordsonmedical.com for part reference. Minimum package quantities vary by tube IDs, please verify minimum package sizes when placing orders.

Y630/655 (-6005)

Y Reduction Connector with 600 Series Barbs, 1/8" x 2 (3.2 mm) and 1/4" (6.4 mm) ID Tubing

Y655/670 (-6005)

Y Reduction Connector with 600 Series Barbs, 1/4" x 2 (6.4 mm) and 3/8" (9.5 mm) ID Tubing

Y670/680 (-6005)

Y Reduction Connector with 600 Series Barbs, 3/8" x 2 (9.5 mm) and 1/2" (12.7 mm) ID Tubing

Y6100/6110 (-6005)

Y Reduction Connector with 600 Series Barbs, 3/4" x 2 (19.0 mm) and 1" (25.4 mm) ID Tubing

Need Samples for Evaluation?

You can call to request most of our standard product in quantities of 5, or less, for free application evaluation.

+1 (970) 267-5200 Toll Free: (888) 404-5837

Need Smaller Fittings?

You can find tube fittings for up to 5/16" (8.0 mm) ID tubing in our selection of Tube Fittings beginning on [page 20](#) and online at www.nordsonmedical.com.

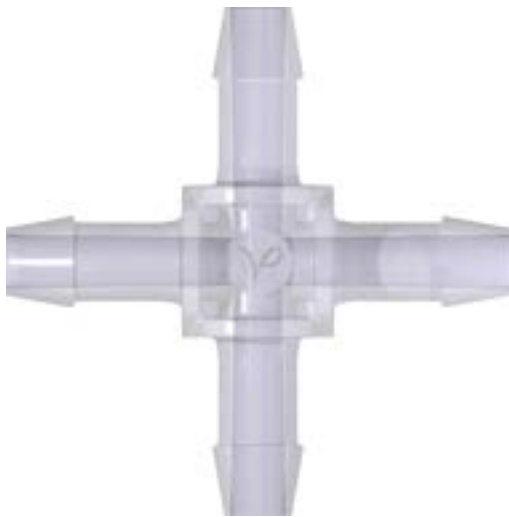

Reference part shown: 4PX670

Due to size we are not able to display all large tube fittings. Please see www.nordsonmedical.com for part reference. Minimum package quantities vary by tube IDs, please verify minimum package sizes when placing orders.

4PX655 (-6005)

Four-Port Cross Style Manifold with 600 Series Barbs for 1/4" (6.4 mm) ID Tubing

4PX670 (-6005)

Four-Port Cross Style Manifold with 600 Series Barbs for 3/8" (9.5 mm) ID Tubing

4PX680 (-6005)

Four-Port Cross Style Manifold with 600 Series Barbs for 1/2" (12.7 mm) ID Tubing

4PX6100 (-6005)

Four-Port Cross Style Manifold with 600 Series Barbs for 3/4" (19.0 mm) ID Tubing

4PX6110 (-6005)

Four-Port Cross Style Manifold with 600 Series Barbs for 1" (25.4 mm) ID Tubing

Need Smaller Fittings?

You can find tube fittings for up to 5/16" (8.0 mm) ID tubing in our selection of Tube Fittings beginning on [page 20](#) and online at www.nordsonmedical.com.



Reference part shown: 4PX670/655

Due to size we are not able to display all large tube fittings. Please see www.nordsonmedical.com for part reference. Minimum package quantities vary by tube IDs, please verify minimum package sizes when placing orders.

4PX670/655 (-6005)

Four-Port Cross Style Manifold with 600 Series Barbs for 3/8" (9.5 mm) and 1/4" x 3 (6.4 mm) ID Tubing

4PX680/670 (-6005)

Four-Port Cross Style Manifold with 600 Series Barbs for 1/2" (12.7 mm) and 3/8" x 3 (9.5 mm) ID Tubing

4PX6110/6100 (-6005)

Four-Port Cross Style Manifold with 600 Series Barbs for 1" (25.4 mm) and 3/4" x 3 (19.0 mm) ID Tubing

LARGE TUBE FITTINGS:
Press-In Plugs



Reference part shown: PIP080

Due to size we are not able to display all large tube fittings. Please see www.nordsonmedical.com for part reference. Minimum package quantities vary by tube IDs, please verify minimum package sizes when placing orders.

PIP070 (-6005)

Press-In Plug with 500 Series Barb, 3/8" (9.5 mm) ID Tubing

PIP670 (-6005)

Press-In Plug with 600 Series Barb, 3/8" (9.5 mm) ID Tubing

PIP080 (-6005)

Press-In Plug with 500 Series Barb, 1/2" (12.7 mm) ID tubing

PIP680 (-6005)

Press-In Plug with 600 Series Barb, 1/2" (12.7 mm) ID Tubing

PIP6100 (-6005)

Press-In Plug with 600 Series Barb, 3/4" (19.0 mm) ID Tubing

PIP6110 (-6005)

Press-In Plug with 600 Series Barb, 1" (25.4 mm) ID Tubing

BLOOD PRESSURE

FITTINGS



BPF Series Female Bayonet Style Connectors
PG-100



BPL Series 1/4 Turn Cuff Connectors
PG-100



Bayonet Male Cuff Connectors
PG-101



Dinamap® Monitor Adapters
PG-101



Dinamap® Cuff Connectors
PG-101



BPF Series

Blood Pressure Fittings

BPF SERIES:
Female Bayonet Style Quick Connect

BPF230 (-001) Black ABS Housing

Bayonet-Style Female Quick Connect Fitting, 200 Series Barb, 1/8" (3.2 mm) ID Tubing



works with...

BPM013
BPM240
BPM025
BPM035

BPF240 (-001) Black ABS Housing

Bayonet-Style Female Quick Connect Fitting, 200 Series Barb, 5/32" (4.0 mm) ID Tubing



works with...

BPM013
BPM240
BPM025
BPM035

BPL Series

Blood Pressure Fittings

BPL SERIES:
Cuff Connectors

BPLF240 (-8012)

Quarter-turn Female Blood Pressure Cuff Connector to 200 Series Barb, 5/32" (4.0 mm) Tubing ID



BPLM230 (-001) White ABS, White Acetal, Buna-N O-Ring

Quarter-turn Male Blood Pressure Cuff Connector to 200 Series Barb, 1/8" (3.2 mm) Tubing ID



BPLM240 (-001) White ABS, White Acetal, Buna-N O-Ring

Quarter-turn Male Blood Pressure Cuff Connector to 200 Series Barb, 5/32" (4.0 mm) Tubing ID



BLOOD PRESSURE: Bayonet Male Cuff Connectors

BPM013 (-1)

Blood Pressure Monitor Bayonet Connector to 500 Series Barb, 80369-5 Compliant, 1/8" (3.2 mm) ID Tubing



BPM240 (-1)

Blood Pressure Monitor Bayonet Connector to 200 Series Barb, 80369-5 Compliant, 5/32" (4.0 mm) ID Tubing

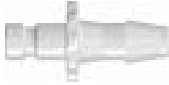

BPM025 (-1)

Blood Pressure Monitor Bayonet Connector to 500 Series Barb, 80369-5 Compliant, 5/32" (4.0 mm) ID Tubing



BPM035 (-1)

Blood Pressure Monitor Bayonet Connector to 500 Series Barb, 80369-5 Compliant, 3/16" (4.8 mm) ID Tubing

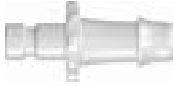

BPMB230 (-1)

Blood Pressure Monitor Bayonet Panel Mount Connector to 200 Series Barb, 80369-5 Compliant, 1/4-28 UNF Thread, 1/8" (3.2 mm) ID Tubing



BLOOD PRESSURE: Panel Mount Nuts

PMSN (-XO)

Panel Mount Nut 1/4-28 UNF with 7/16" Hex (For use with BPMB230)



BLOOD PRESSURE: Dinamap® Monitor Adapters

BPA025 (-001) Black Nylon over White Nylon

Blood Pressure Adapter with Internal 5/16-24 UNF Thread and O-Ring to 500 Series Barb, 5/32" (4.0 mm) ID Tubing



BPA035 (-001) Black Nylon over White Nylon

Blood Pressure Adapter with Internal 5/16-24 UNF Thread and O-Ring to 500 Series Barb, 3/16" (4.8 mm) ID Tubing



BLOOD PRESSURE: Dinamap® Cuff Connectors

BPCL220 (-81)

Blood Pressure Adapter with 5/16-24 UNF Thread and 6% Taper to 200 Series Barb, 3/32" (2.4 mm) ID Tubing



BPCL240 (-10)

Blood Pressure Adapter with 5/16-24 UNF Thread and 6% Internal Taper to 200 Series Barb, 5/32" (4.0 mm) ID Tubing

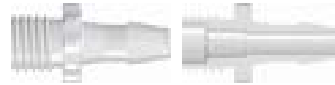

BPC240 (-10)

Blood Pressure Adapter with 5/16-24 UNF Thread to 200 Series Barb, 5/32" (4.0 mm) ID Tubing

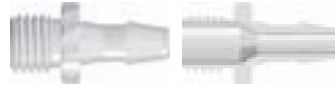

BPCL250 (-81)

Blood Pressure Adapter with 5/16-24 UNF Thread and 6% Internal Taper to 200 Series Barb, 3/16" (4.8 mm) ID Tubing



CF229 (-1)

Neonatal Blood Pressure Slip Fit (non luer) with 200 Series Barb, 3/32" (2.4 mm) ID Tubing



CF230 (-1)

Neonatal Blood Pressure Slip Fit (non luer) with 200 Series Barb, 5/32" (4.0 mm) ID Tubing



Technical Assistance

Trying to choose the correct part? Need more material information than is published in this catalog? Call Nordson MEDICAL Technical Support **(970) 267-5200**.

THREADED

FITTINGS



10-32 UNF Special Tapered Thread **PG-103 PG-106**



1/4-28 UNF Bottom Sealing **PG-107** Metric - M6x1 **PG-108**



Metric - M5x.8 **PG-108** 1/16-27 NPT **PG-109**



1/8-27 NPT **PG-110** 1/8-27 NPT Reducers **PG-111**



The X Thread

Nordson MEDICAL X Series components have a tapered 10-32 thread that functions like a pipe thread. In comparison to standard 10-32 UNF threaded fittings, the tapered design works better with oversized ports and ports which are not perpendicular to the face of the component.

The 120 degree chamfer under the hex provides a seal when the fitting is tightened into a port with a countersink as shown below. It also seals on the thread due to interference on the pitch diameter. When using an elbow or tee, the tapered thread tightens radially and facilitates directional alignment of the barb.

Other Thread Series

K, B, C and D Series fittings, designed for use with 10-32 UNF ports, are straight-threaded components. These fittings seal against the 120 degree chamfer under the hex on the fitting and do not tighten radially as they are assembled. S Series fittings are straight threaded components for 1/4-28 UNF ports, M5 Series are for M5 x .8 ports and M6 Series are for M6 x 1 ports.

Part numbers for fittings with pipe threads are noted below. Those for use with 1/16-27 NPT ports have part numbers prefixed with 16; those for 1/8-27 NPT ports have part numbers prefixed with 18; and those for 1/4-18 NPT ports have part numbers prefixed with 14.

The features shown below must be incorporated into the port when using our B, C, D, X, K, S, M5 and M6 Series fittings. Failure to do so will jeopardize the performance of the seal between the fitting and port. For applications in which this seal is highly critical, we recommend that you contact a sealant specialist.

When working with threaded parts, Nordson MEDICAL strongly recommends that you test sample parts in your application.

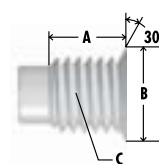

Nordson MEDICAL's Thread Series	Dimension A Thread Length	Clearance Needed to Achieve Chamfer Seal	Dimension B Countersink Diameter	Feature C Internal Screw Thread Series
X	.200"	.250"	.210"-.230"	10-32 UNF 2B
K, B, C, D	.156"	.200"	.210"-.230"	10-32 UNF 2B
S	.204"	.250"	.270"-.290"	1/4-28 UNF 2B
M5	.192"	.250"	.210"-.230"	M5 X .8
M6	.235"	.375"	.270"-.290"	M6 X 1

THREAD: 10-32 UNF, Special Tapered Thread

X10 (-2)

10-32 Special Tapered Thread with 1/4" Hex to Classic Series Barb, 1/16" (1.6 mm) ID Tubing



K210 (-1 -3 -5 -J2A)

10-32 UNF Thread with 1/4" Hex to 200 Series Barb, 1/16" (1.6 mm) ID Tubing



X210 (-1 -3 -6005 -J2A)

10-32 Special Tapered Thread with 1/4" Hex to 200 Series Barb, 1/16" (1.6 mm) ID Tubing



K410 (-1 -2)

10-32 UNF Thread with 1/4" Hex to 400 Series Barb, 1/16" (1.6 mm) ID Tubing



X410 (-6005)

10-32 Special Tapered Thread with 1/4" Hex to 400 Series Barb, 1/16" (1.6 mm) ID Tubing



D (-3 -4 -5)

10-32 UNF Thread with 1/4" Hex to Classic Series Barb, 3/32" (2.4 mm) ID Tubing



K220 (-6012)

10-32 UNF Thread with 1/4" Hex to 200 Series Barb, 3/32" (2.4 mm) ID Tubing



X220 (-1 -6005)

10-32 Special Tapered Thread with 1/4" Hex to 200 Series Barb, 3/32" (2.4 mm) ID Tubing



K420 (-1 -6005)

10-32 UNF Thread with 1/4" Hex to 400 Series Barb, 3/32" (2.4 mm) ID Tubing



X420 (-1 -2 -6005)

10-32 Special Tapered Thread with 1/4" Hex to 400 Series Barb, 3/32" (2.4 mm) ID Tubing



B (-3 -4 -5 -6005)

10-32 UNF Thread with 1/4" Hex to Classic Series Barb, 1/8" (3.2 mm) ID Tubing



C (-3 -4 -5)

10-32 UNF Thread with 1/4" Hex to Classic Series Barb, Short Neck, 1/8" (3.2 mm) ID Tubing



K230 (-1)

10-32 UNF Thread with 1/4" Hex to 200 Series Barb, 1/8" (3.2 mm) ID Tubing



X230 (-1 -2 -6012)

10-32 Special Tapered Thread with 1/4" Hex to 200 Series Barb, 1/8" (3.2 mm) ID Tubing



K430 (-1 -2)

10-32 UNF Thread with 1/4" Hex to 400 Series Barb, 1/8" (3.2 mm) ID Tubing



X430 (-1 -3 -6005)

10-32 Special Tapered Thread with 1/4" Hex to 400 Series Barb, 1/8" (3.2 mm) ID Tubing



K240 (-2 -6005)

10-32 UNF Thread with 1/4" Hex to 200 Series Barb, 5/32" (4.0 mm) ID Tubing



X240 (-2)

10-32 Special Tapered Thread with 1/4" Hex to 200 Series Barb, 5/32" (4.0 mm) ID Tubing



K445 (-6005)

10-32 UNF Thread with 1/4" Hex to 400 Series Barb, .170" (4.3 mm) ID Tubing



X445 (-2 -6005)

10-32 Special Tapered Thread with 1/4" Hex to 400 Series Barb, .170" (4.3 mm) ID Tubing



THREAD: 10-32 UNF, Special Tapered Thread Elbow

KL210 (-1 -6005)

10-32 UNF Thread Elbow with 1/4" Hex to 200 Series Barb, 1/16" (1.6 mm) ID Tubing



XL210 (-1 -6005)

10-32 Special Tapered Thread Elbow with 1/4" Hex to 200 Series Barb, 1/16" (1.6 mm) ID Tubing



KL410 (-1 -2 -6005)

10-32 UNF Thread Elbow with 1/4" Hex to 400 Series Barb, 1/16" (1.6 mm) ID Tubing



XL410 (-1 -6005)

10-32 Special Tapered Thread Elbow with 1/4" Hex to 400 Series Barb, 1/16" (1.6 mm) ID Tubing



XL220 (-2 -6012)

10-32 Special Tapered Thread Elbow with 1/4" Hex to 200 Series Barb, 3/32" (2.4 mm) ID Tubing



KL420 (-1 -2 -6005)

10-32 UNF Thread Elbow with 1/4" Hex to 400 Series Barb, 3/32" (2.4 mm) ID Tubing



XL420 (-6005)

10-32 Special Tapered Thread Elbow with 1/4" Hex to 400 Series Barb, 3/32" (2.4 mm) ID Tubing



KL230 (-1)

10-32 UNF Thread Elbow with 1/4" Hex to 200 Series Barb, 1/8" (3.2 mm) ID Tubing



XL230 (-1 -2)

10-32 Special Tapered Thread Elbow with 1/4" Hex to 200 Series Barb, 1/8" (3.2 mm) ID Tubing



KL430 (-1 -6005)

10-32 UNF Thread Elbow with 1/4" Hex to 400 Series Barb, 1/8" (3.2 mm) ID Tubing



Custom Assembly

We produce standard components to fit your current assemblies and devices, but we also provide custom solutions by applying a variety of assembly options, such as joining fittings, connectors, filters, and other components to tubing. From systems using a single fitting to complex configurations utilizing various components, we can design complete assemblies to your requirements.

THREAD:
10-32 UNF, Special Tapered Thread Tee

KT210 (-6005)

10-32 UNF Thread Tee with 1/4" Hex to 200 Series Barb,
1/16" (1.6 mm) ID Tubing



KT420 (-1 -2 -6005)

10-32 UNF Thread Tee with 1/4" Hex to 400 Series Barb,
3/32" (2.4 mm) ID Tubing



XT210 (-J2A)

10-32 Special Tapered Thread Tee with 1/4" Hex to 200 Series Barb,
1/16" (1.6 mm) ID Tubing



XT420 (-1 -2 -6005)

10-32 Special Tapered Thread Tee with 1/4" Hex to 400 Series Barb,
3/32" (2.4 mm) ID Tubing



KT410 (-1 -2 -6005)

10-32 UNF Thread Tee with 1/4" Hex to 400 Series Barb,
1/16" (1.6 mm) ID Tubing



KT230 (-6005)

10-32 UNF Thread Tee with 1/4" Hex to 200 Series Barb,
1/8" (3.2 mm) ID Tubing



XT410 (-1 -2 -6005)

10-32 Special Tapered Thread Tee with 1/4" Hex to 400 Series Barb,
1/16" (1.6 mm) ID Tubing



KT430 (-1 -2 -6005)

10-32 UNF Thread Tee with 1/4" Hex to 400 Series Barb,
1/8" (3.2 mm) ID Tubing



KT220 (-2 -6005)

10-32 UNF Thread Tee with 1/4" Hex to 200 Series Barb,
3/32" (2.4 mm) ID Tubing



XT430 (-1 -6005)

10-32 Special Tapered Thread Tee with 1/4" Hex to 400 Series Barb,
1/8" (3.2 mm) ID Tubing



Part Drawings Online!

Nordson MEDICAL provides dimensional drawings available for download for all of its fittings.

www.nordsonmedical.com

THREAD:
 10-32 UNF, Special Tapered Thread Couplers and Plugs

KN (-2)

10-32 UNF Thread Coupler with 1/4" Hex

XN (-2 -6005)

10-32 Special Tapered Thread Coupler with 1/4" Hex

KP (-6012)

10-32 UNF Thread Plug with 1/4" Hex

THREAD:
 1/4-28 UNF

S10 (-2)

 1/4-28 UNF Thread with 5/16" Hex to Classic Series Barb,
 1/16" (1.6 mm) ID Tubing

S410 (-1 -2 -6005)

 1/4-28 UNF Thread with 5/16" Hex to 400 Series Barb,
 1/16" (1.6 mm) ID Tubing

S20 (-2)

 1/4-28 UNF Thread with 5/16" Hex to Classic Series Barb,
 3/32" (2.4 mm) ID Tubing

S220 (-2 -6005)

 1/4-28 UNF Thread with 5/16" Hex to 200 Series Barb,
 3/32" (2.4 mm) ID Tubing

S420 (-1 -2 -J2A)

 1/4-28 UNF Thread with 5/16" Hex to 400 Series Barb,
 3/32" (2.4 mm) ID Tubing

S230 (-1 -2 -6005)

 1/4-28 UNF Thread with 5/16" Hex to 200 Series Barb,
 1/8" (3.2 mm) ID Tubing

Looking for Something Different?

Most of our best product ideas have come from you, our customers. While we pride ourselves on our extensive product offering, we recognize that your needs are ever-changing and that our products, too, must adapt to your needs.

If there's a new product you think Nordson MEDICAL should make, please send us an Email at Orders@nordsonmedical.com describing your product concept in as much detail as you desire. We will contact you with any questions, and who knows - the next catalog edition could include products YOU told us to build.

See page 8-9 for more information on custom engineered solutions!



THREAD:
1/4-28 UNF**S430 (-2)**1/4-28 UNF Thread with 5/16" Hex to 400 Series Barb,
1/8" (3.2 mm) ID Tubing**S40 (-6005)**1/4-28 UNF Thread with 5/16" Hex to Classic Series Barb,
5/32" (4.0 mm) ID Tubing**S240 (-6005)**1/4-28 UNF Thread with 5/16" Hex to 200 Series Barb,
5/32" (4.0 mm) ID Tubing**S445 (-2)**1/4-28 UNF Thread with 5/16" Hex to 400 Series Barb,
.170" (4.3 mm) ID Tubing**S50 (-1)**1/4-28 UNF Thread with 5/16" Hex to Classic Series Barb,
3/16" (4.8 mm) ID Tubing**S250 (-J2A)**1/4-28 UNF Thread with 5/16" Hex to 200 Series Barb,
3/16" (4.8 mm) ID Tubing**S450 (-2)**1/4-28 UNF Thread with 5/16" Hex to 400 Series Barb,
3/16" (4.8 mm) ID Tubing**SP (-1 -6005)**

1/4-28 UNF Thread Plug with 5/16" Hex

**THREAD:**
1/4-28 UNF Bottom Sealing**ABR004-6005 UNDER (-1)**1/4-28 UNF Bottom Sealing Rotating Thread with 5/16" Hex to
500 Series Barb, 1/16" (1.6 mm) ID TubingRecommended torque:
Polypropylene - 1.5-2 in. lbs.
Kynar® - 2-4 in. lbs.**ABR004-J2A UNDER (-1 -2 -3 -4 -J2A)**1/4-28 UNF Bottom Sealing Rotating Thread with 5/16" Hex to
500 Series Barb, 1/16" (1.6 mm) ID TubingRecommended torque:
Polypropylene - 1.5-2 in. lbs.
Kynar® - 2-4 in. lbs.**ABR007-6005 UNDER (-1 -2 -4)**1/4-28 UNF Bottom Sealing Rotating Thread with 5/16" Hex to
500 Series Barb, 3/32" (2.4 mm) ID TubingRecommended torque:
Polypropylene - 1.5-2 in. lbs.
Kynar® - 2-4 in. lbs.**ABR013-6005 UNDER (-1 -4 -6012)**1/4-28 UNF Bottom Sealing Rotating Thread with 5/16" Hex to
500 Series Barb, 1/8" (3.2 mm) ID TubingRecommended torque:
Polypropylene - 1.5-2 in. lbs.
Kynar® - 2-4 in. lbs.**ABR013-J2A UNDER (-1 -4 -J2A)**1/4-28 UNF Bottom Sealing Rotating Thread with 5/16" Hex to
500 Series Barb, 1/8" (3.2 mm) ID TubingRecommended torque:
Polypropylene - 1.5-2 in. lbs.
Kynar® - 2-4 in. lbs.

THREAD:
M6x1**M6210 (-2 -6005)**

M6x1 Thread with 5/16" Hex to 200 Series Barb, 1/16" (1.6 mm) ID Tubing

**M6410 (-1 -2 -6005)**

M6x1 Thread with 5/16" Hex to 400 Series Barb, 1/16" (1.6 mm) ID Tubing

**M6220 (-2 -6005)**

M6x1 Thread with 5/16" Hex to 200 Series Barb, 3/32" (2.4 mm) ID Tubing

**M6420 (-1 -2 -6005)**

M6x1 Thread with 5/16" Hex to 400 Series Barb, 3/32" (2.4 mm) ID Tubing

**M6230 (-1 -2 -6005)**

M6x1 Thread with 5/16" Hex to 200 Series Barb, 1/8" (3.2 mm) ID Tubing

**M6430 (-6005)**

M6x1 Thread with 5/16" Hex to 400 Series Barb, 1/8" (3.2 mm) ID Tubing

**M6240 (-2)**

M6x1 Thread with 5/16" Hex to 200 Series Barb, 5/32" (4.0 mm) ID Tubing

**M6445 (-1 -6005)**

M6x1 Thread with 5/16" Hex to 400 Series Barb, .170" (4.3 mm) ID Tubing

**THREAD:**
M6x1**M6250 (-1 -2 -6005)**

M6x1 Thread with 5/16" Hex to 200 Series Barb, 3/16" (4.8 mm) ID Tubing

**M6450 (-1 -2 -6005)**

M6x1 Thread with 5/16" Hex to 400 Series Barb, 3/16" (4.8 mm) ID Tubing

**THREAD:**
M5x.8**M5210 (-1)**

M5x.8 Thread with 1/4" Hex to 200 Series Barb, 1/16" (1.6 mm) ID Tubing

**M5220 (-1)**

M5x.8 Thread with 1/4" Hex to 200 Series Barb, 3/32" (2.4 mm) ID Tubing

**M5230 (-1)**

M5x.8 Thread with 1/4" Hex to 200 Series Barb, 1/8" (3.2 mm) ID Tubing

**M5240 (-2)**

M5x.8 Thread with 1/4" Hex to 200 Series Barb, 5/32" (4.0 mm) ID Tubing

**Need Samples for Evaluation?**

You can call to request most of our standard product in quantities of 5, or less, for free application evaluation.

+1 (970) 267-5200 Toll Free: (888) 404-5837

Need it Fast?

You can order our parts online now with no order \$ minimums, 24 hours a day, 7 days a week!

www.nordsonmedical.com

THREAD:
 1/16-27 NPT

1610 (-6005)

 1/16-27 NPT Thread with 5/16" Hex to Classic Series Barb,
 1/16" (1.6 mm) ID Tubing

16210 (-1)

 1/16-27 NPT Thread with 5/16" Hex to 200 Series Barb,
 1/16" (1.6 mm) ID Tubing

16410 (-1 -2 -6005)

 1/16-27 NPT Thread with 5/16" Hex to 400 Series Barb,
 1/16" (1.6 mm) ID Tubing

1620 (-1 -6005)

 1/16-27 NPT Thread with 5/16" Hex to Classic Series Barb,
 3/32" (2.4 mm) ID Tubing

16220 (-1 -2)

 1/16-27 NPT Thread with 5/16" Hex to 200 Series Barb,
 3/32" (2.4 mm) ID Tubing

16420 (-1 -2 -6005)

 1/16-27 NPT Thread with 5/16" Hex to 400 Series Barb,
 3/32" (2.4 mm) ID Tubing

1630 (-1 -2 -6005)

 1/16-27 NPT Thread with 5/16" Hex to Classic Series Barb,
 1/8" (3.2 mm) ID Tubing

16230 (-6005 -J2A)

 1/16-27 NPT Thread with 5/16" Hex to 200 Series Barb,
 1/8" (3.2 mm) ID Tubing

16430 (-1 -2)

 1/16-27 NPT Thread with 5/16" Hex to 400 Series Barb,
 1/8" (3.2 mm) ID Tubing

1640 (-1 -2 -6005)

 1/16-27 NPT Thread with 5/16" Hex to Classic Series Barb,
 5/32" (4.0 mm) ID Tubing

16240 (-2 -6005)

 1/16-27 NPT Thread with 5/16" Hex to 200 Series Barb,
 5/32" (4.0 mm) ID Tubing

16445 (-6005)

 1/16-27 NPT Thread with 5/16" Hex to 400 Series Barb,
 .170" (4.3 mm) ID Tubing

1650 (-2 -6005)

 1/16-27 NPT Thread with 5/16" Hex to Classic Series Barb,
 3/16" (4.8 mm) ID Tubing

16250 (-2 -6005)

 1/16-27 NPT Thread with 5/16" Hex to 200 Series Barb,
 3/16" (4.8 mm) ID Tubing

16450 (-1 -2 -6005)

 1/16-27 NPT Thread with 5/16" Hex to 400 Series Barb,
 3/16" (4.8 mm) ID Tubing

1600 (-2)

1/16-27 NPT Thread Plug with 5/16" Hex



**THREAD:
1/8-27 NPT****18210 (-1 -J2A)**

1/8-27 NPT Thread with 7/16" Hex to 200 Series Barb,
1/16" (1.6 mm) ID Tubing

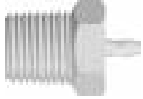
**18230 (-1 -6005 -J2A)**

1/8-27 NPT Thread with 7/16" Hex to 200 Series Barb,
1/8" (3.2 mm) ID Tubing

**18410 (-1 -2 -6005)**

1/8-27 NPT Thread with 7/16" Hex to 400 Series Barb,
1/16" (1.6 mm) ID Tubing

**18430 (-2)**

1/8-27 NPT Thread with 7/16" Hex to 400 Series Barb,
1/8" (3.2 mm) ID Tubing

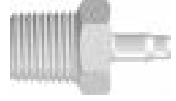
**1820 (-2)**

1/8-27 NPT Thread with 7/16" Hex to Classic Series Barb,
3/32" (2.4 mm) ID Tubing

**1840 (-2)**

1/8-27 NPT Thread with 7/16" Hex to Classic Series Barb,
5/32" (4.0 mm) ID Tubing

**18220 (-1)**

1/8-27 NPT Thread with 7/16" Hex to 200 Series Barb,
3/32" (2.4 mm) ID Tubing

**18240 (-6005)**

1/8-27 NPT Thread with 7/16" Hex to 200 Series Barb,
5/32" (4.0 mm) ID Tubing

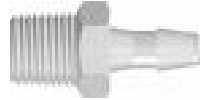
**18420 (-1 -6005)**

1/8-27 NPT Thread with 7/16" Hex to 400 Series Barb,
3/32" (2.4 mm) ID Tubing

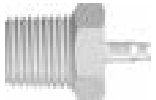
**18445 (-1 -2)**

1/8-27 NPT Thread with 7/16" Hex to 400 Series Barb,
.170" (4.3 mm) ID Tubing

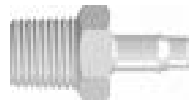
**1830 (-1)**

1/8-27 NPT Thread with 7/16" Hex to Classic Series Barb,
1/8" (3.2 mm) ID Tubing

**1850 (-1 -6005)**

1/8-27 NPT Thread with 7/16" Hex to Classic Series Barb,
3/16" (4.8 mm) ID Tubing

**1860 (-1 -6005 -6012)**

1/8-27 NPT Thread with 7/16" Hex to Classic Series Barb,
1/4" (6.4 mm) ID Tubing



THREAD:
1/8-27 NPT Elbows

18L230 (-1 -2 -6005 -J2A)

1/8-27 NPT Thread Elbow with 7/16" Hex to 200 Series Barb,
1/8" (3.2 mm) ID Tubing



18L250 (-1 -6005)

1/8-27 NPT Thread Elbow with 7/16" Hex to 200 Series Barb,
3/16" (4.8 mm) ID Tubing



18L260 (-1 -2 -6005)

1/8-27 NPT Thread Elbow with 7/16" Hex to 200 Series Barb,
1/4" (6.4 mm) ID Tubing



THREAD:
1/8-27 NPT Tees

18T260 (-1 -2)

1/8-27 NPT Thread Tee with 7/16" Hex to 200 Series Barb,
1/4" (6.4 mm) ID Tubing



THREAD:
1/8-27 NPT Reducers

1802 (-2 -6005)

Reducer with 1/8-27 NPT Male Thread and 7/16" Hex to
1/4-28 UNF Female Thread

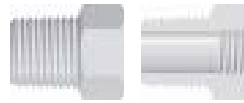

Need More Details?

Part drawings, minimum order quantities, and CAD requests can be found online. Visit www.nordsonmedical.com or contact Sales at Orders@nordsonmedical.com.

BUILD-A-PART

FITTINGS



Junction Blocks PG-113



Accessories PG-114



Barbs PG-114



Threads PG-115



Bonding Suggestions

Prior to actually bonding, press together a model of the manifold to use as a reference.

Do not mix plastic resins. Consult your adhesive specialist if you need to bond dissimilar materials.

These components are designed for bonding with any one of a number of solvents, but other adhesive systems may be used. When solvent bonding, use a very small gauge needle (typically 27 or 30) for best solvent control. Consult your adhesive specialist for guidance on other systems.

Apply solvent sparingly. Most solvents are low viscosity and readily wick into the bondline. Excessive solvent may compromise the aesthetics and the function of the assembly.

Press the mating components together leaving a .01-.03" gap between them for the solvent. Place the components in an orientation such that they may be rotated ¼ turn to their final position after applying the solvent.

After applying solvent, wait a few seconds, then rotate the components to their final position. When making a long manifold with bondable junction blocks it may be helpful to push the assembly against a flat surface to align the blocks before the solvent has set.

Affordable Unique Solutions:

Design Your New Component with Build-a-Part® Bondable Components!



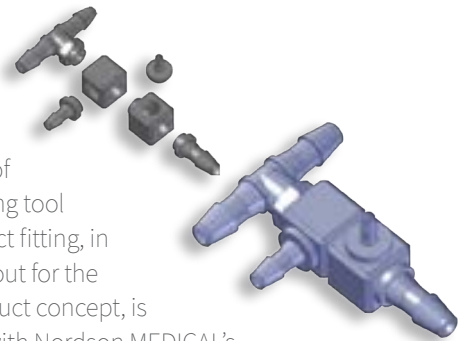







Component designers no longer need to be constrained by the limitations of injection molding tool design. The exact fitting, in the optimal layout for the process or product concept, is now available with Nordson MEDICAL's line of Build-a-Part® bondable components, designed for use with gases or liquids.









The Build-a-Part® system is based on combining interchangeable components, joining junction blocks and luers, hose barbs or threaded features to create the desired configuration. The features are bonded to the junction blocks using commonly available adhesives. Junction blocks and features may be bonded together to create multi-port, multi-axis products that receive and redirect fluid flow in whatever direction the designer desires. The only limitation is the designer's imagination.

Several component options are available from stock in two primary materials. Options include ISO 594-1 compliant male and female luers and hose barbs in 1/16" (1.6 mm), 3/32" (2.4 mm) and 1/8" (3.2 mm) in straight, elbow and branch tee configurations. Also available are male threads including 10-32 UNF, 1/16-27 NPT, 1/8-27 NPT, 1/4-28 UNF and M6x1 versions, and mounting devices.

The complete range is available in two primary resins: white ABS or translucent polysulfone. For ease of testing concepts, Nordson MEDICAL offers designer kits in both resins. Each kit contains hundreds of components for prototype purposes, enabling designs to be created and modified prior to production commitment.

BLOCK	NUMBER	MATERIAL
Build-A-Part® Junction Blocks. See Configuration Table for specifications.		
	BDJ05-40	Polysulfone
	BDJ06-40	Polysulfone
	BDJ07-40 BDJ07-81	Polysulfone Lace White ABS
	BDJ08-40 BDJ08-81	Polysulfone Lace White ABS
	BDJ09-40	Polysulfone
	BDJ10-40 BDJ10-81	Polysulfone Lace White ABS
	BDJ11-40	Polysulfone
	BDJ13-40	Polysulfone
	BDJ14-40*	Polysulfone
	BDJ15-40*	Polysulfone

*Check valve junction block. For use with RB01 and SB01

BLOCK	NUMBER	MATERIAL
Build-A-Part® Junction Blocks with Mounting Port. See Configuration Table for specifications.		
	BDJ16-81*	Lace White ABS
	BDJ17-40* BDJ17-81*	Polysulfone Lace White ABS
	BDJ18-40 BDJ18-81	Polysulfone Lace White ABS
	BDJ19-40 BDJ19-81	Polysulfone Lace White ABS
	BDJ20-40 BDJ20-81	Polysulfone Lace White ABS
	BDJ21-40 BDJ21-81	Polysulfone Lace White ABS
	BDJ22-40	Polysulfone

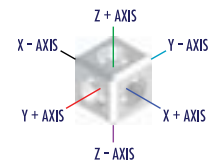

Build-A-Part® Junction Block Configuration Table

BLOCK	X+ AXIS	X- AXIS	Y+ AXIS	Y- AXIS	Z+ AXIS	Z- AXIS
BDJ05	Female		Female		Female	
BDJ06	Female		Female		Female	Female
BDJ07	Female	Female	Female	Female	Female	
BDJ08	Female	Female	Female	Female	Female	Female
BDJ09	Male	Female	Female		Female	Female
BDJ10	Male	Female	Female	Female	Female	Female
BDJ11	Male	Female	Female	Female		
BDJ13	Male	Female	Female		Female	
BDJ14	Male	Female				
BDJ15	Female	Female				
BDJ16	Female	Female		Female ^a		
BDJ17	Male	Female	Female ^a			
BDJ18	Male ^b	Female	Female		Female	Female
BDJ19	Male ^b	Female	Female	Female	Female	Female
BDJ20	Male ^b	Female	Female	Female		
BDJ21	Male ^b	Female	Female			
BDJ22	Male ^b	Female	Female		Female	

^aFor non-flow manifolding ^bFor use with BDMD

BUILD-A-PART®:
 Accessories, Barbs and Elbows

RB01 (-X2) SB01 (-X0)

Check Valve Ball 5/32" Diameter

BDMFTLL (-9)

Bondable Female Luer Thread Style

RMLLR (-5 -07 -6005 -9 -9002)

Rotating Male Luer Lock Ring (For use with BDMMTL)

BDMR210 (-81)

Bondable 200 Series Barb, 1/16" (1.6 mm) ID Tubing

BDMR220 (-81)

Bondable 200 Series Barb, 3/32" (2.4 mm) ID Tubing

BDMR230 (-81)

Bondable 200 Series Barb, 1/8" (3.2 mm) ID Tubing

BDMR240 (-6005)

Bondable 200 Series Barb, 5/32" (4.0 mm) ID Tubing

BDMR445 (-81)

Bondable 400 Series Barb, .170" (4.3 mm) ID Tubing

BDML220 (-9)

Bondable Elbow 200 Series Barb, 3/32" (2.4 mm) ID Tubing

BDML420 (-40)

Bondable Elbow 400 Series Barb, 3/32" (2.4 mm) ID Tubing

BUILD-A-PART®:
 Tees

BDMT210 (-40)

Bondable Tee 200 Series Barb, 1/16" (1.6 mm) ID Tubing

BDMT410 (-40)

Bondable Tee 400 Series Barb, 1/16" (1.6 mm) ID Tubing

BDMT220 (-40)

Bondable Tee 200 Series Barb, 3/32" (2.4 mm) ID Tubing

BDMT420 (-40)

Bondable Tee 400 Series Barb, 3/32" (2.4 mm) ID Tubing

BDMT230 (-81)

Bondable Tee 200 Series Barb, 1/8" (3.2 mm) ID Tubing

BDMT430 (-40)

Bondable Tee 400 Series Barb, 1/8" (3.2 mm) ID Tubing

Did You Know?

Nordson MEDICAL has an interactive PDF available online at www.nordsonmedical.com. Access part drawings, reference charts, data sheets, and more from just one location!

BUILD-A-PART®: Threads

BDMK (-40 -81)

Bondable 10-32 UNF Thread with 1/4" Hex



BDMX (-40)

Bondable 10-32 Special Tapered Thread with 1/4" Hex



BDMM6 (-40 -81)

Bondable M6x1 Thread with 5/16" Hex



BDM16 (-40 -81)

Bondable 1/16-27 NPT Thread with 5/16" Hex



BDM18 (-40)

Bondable 1/8-27 NPT Thread with 7/16" Hex



BDF16 (-40 -81)

Bondable 1/16-27 NPT Thread with 5/16" Hex



BDF18 (-40 -81)

Bondable 1/8-27 NPT Thread with 7/16" Hex



BDFM6 (-40 -81)

Bondable M6x1 Thread with 5/16" Hex



BDFS (-40 -81)

Bondable 1/4-28 UNF Thread with 5/16" Hex



Technical Assistance

Trying to choose the correct part? Need more material information than is published in this catalog? Call Nordson MEDICAL Technical Support **(970) 267-5200**.

Looking for Something Different?

Most of our best product ideas have come from you, our customers. While we pride ourselves on our extensive product offering, we recognize that your needs are ever-changing and that our products, too, must adapt to your needs.

If there's a new product you think Nordson MEDICAL should make, please send us an Email at Orders@nordsonmedical.com describing your product concept in as much detail as you desire. We will contact you with any questions, and who knows - the next catalog edition could include products YOU told us to build.

See page 8-9 for more information on custom engineered solutions!



TUBING

MEDICAL GRADE



LLDP Tubing
PG-116

TPE Tubing
PG-116



Platinum-Cured Silicone Tubing **PG-117**

Pump Grade Platinum-Cured Silicone Tubing **PG-117**



Polyurethane Tubing **PG-117**

Anti-Microbial PVC Tubing **PG-117**



TUBING: Linear Low Density Polyethylene

92 Durometer: This tubing has excellent mechanical and chemical resistance properties. Please use caution if your application involves possible bending or kinking the tubing. It is a semi-rigid material and will be permanently deformed if kinked or bent too tight.

Resin Grade & Technical Information: This tubing is extruded from Equistar® LLDPE, which is in compliance with all U.S. Food & Drug Administration regulations for food grade use under Title 21 CFR. It can be sterilized by gamma radiation or Ethylene Oxide (EtO) gas. Autoclaving is not recommended.

DIMENSION (ID X OD X LGTH)	NUMBER
1/16" X 1/10" X 1000'	LLDPE02-1019M
3/32" X 5/32" X 1000'	LLDPE02-2031M
1/8" X 3/16" X 1000'	LLDPE02-3031M

TUBING: Thermoplastic Elastomer (TPE)

65 Shore A: Our Biopharmaceutical-grade TPE tubing is sterile weldable, heat sealable, moldable, and offers excellent life in peristaltic pumps. It is ideal for use in single-use processes for sampling, filling, and storage tubing set assemblies.

Resin Grade & Technical Information: This tubing is made from FDA-approved ingredients, certified free of silicone oils and animal derived ingredients, and is sterilizable by autoclave or gamma irradiation. It meets various ISO and USP standards, including Class VI, as well as European Pharmacopoeia 3.2.2.1. It also offers excellent low absorption and permeability as compared to silicone tubing.

DIMENSION (ID X OD X LGTH)	NUMBER
3/4" X 1" X 50'	AF7500753

TUBING:
Platinum-Cured Silicone

50 Shore A: Extruded from a low-volatile grade, platinum-cured compound, this tubing is ideal for critical applications in pharmaceutical, biotech, medical, food, and beverage industries.

Resin Grade & Technical Information: This tubing is extruded and packaged in a Class 7 (Class 10,000) ISO-certified clean room. It has undergone extensive physical, chemical, and biological testing and meets USP Class VI, FDA CFR 177.2600, ISO 10993, European Pharmacopoeia 3.1.9, and 3-A standards. It is certified free of animal-derived ingredients and is certified by the National Sanitation Foundation for use in food equipment materials (NSF-51). It offers a temperature range use of -100° F (-73.3° C) to 400° F (204.4° C) and is sterilizable by autoclave or gamma irradiation.

DIMENSION (ID X OD X LGTH)	NUMBER
1/16" X 3/16" X 500'	SILC7001422
1/8" X 1/4" X 50'	SILC7001657
5/32" X 9/32" X 100'	SILC7001839

TUBING:
Pump Grade Platinum-Cured Silicone

DIMENSION (ID X OD X LGTH)	NUMBER
1/4" X 7/16" X 300'	SILPG7021041
3/16" X 3/8" X 250'	SILPG7021042
1/8" X 1/4" X 500'	SILPG7021043
1/16" X 3/16" X 500'	SILPG7021044

Part Drawings Online!

Nordson MEDICAL provides dimensional drawings available for download for all of its fittings.
www.nordsonmedical.com

TUBING:
Polyurethane

80 Durometer: This tubing is extremely kink resistant and highly resistant to abrasion and scuffing. It is widely accepted as a premium material for medical device use because of its flexible nature and easy sterilizability.

Resin Grade & Technical Information: This tubing is extruded from Lubrizol's® compound Pellethane PUR80A-MED, which has passed USP Class VI testing. It can be sterilized by gamma radiation or Ethylene Oxide (EtO) gas. Please do not autoclave this tubing, as it may alter the chemical nature of the resin.

DIMENSION (ID X OD X LGTH)	NUMBER
1/16" X 1/8" X 100'	UR00-1031C
1/16" X 1/8" X 1000'	UR00-1031M
3/32" X 3/16" X 100'	UR00-2047C
3/32" X 3/16" X 1000'	UR00-2047M
1/8" X 1/4" X 100'	UR00-3062C
1/8" X 1/4" X 1000'	UR00-3062M

TUBING:
Anti-Microbial Polyvinyl Chloride (PVC)

Ag-47 Clear Anti-Microbial: CLEARFLO Ag-47 is suitable for a wide variety of food contact applications and designed to protect your food or beverage product from harmful bacteria. It's manufactured from a clear flexible Shore A74 PVC compound with the addition of antimicrobial protection. The antimicrobial technology is especially effective where there is infrequent use of fluids in warm conditions.

Resin Grade & Technical Information: CLEARFLO Ag-47 offers antibacterial performance to ISO 22196:2011. Unlike some products CLEARFLO Ag-47 is 100% protected with the effective additive Silver-Magnesium-Aluminum-Phosphorus Complex. This is present throughout the tube and not only on the interior, offering you protection on all surfaces. The active ingredients in CLEARFLO Ag-47 will have no detrimental effect on yeasts used for brewing and will have no negative impact on the taste or flavor of products passed through it.

DIMENSION (ID X OD X LGTH)	NUMBER
3/16" X 5/16" X 100'	PVCA1190035
3/16" X 7/16" X 100'	PVCA1190049
1/4" X 1/2" X 100'	PVCA1190126
5/16" X 7/16" X 100'	PVCA1190189
5/16" X 9/16" X 100'	PVCA1190203
3/8" X 5/8" X 100'	PVCA1190280
1/2" X 3/4" X 100'	PVCA1190357



OTHER

COMPONENTS

Tapered Seal
PG-118



Clamps
PG-119



Injection Sites
PG-119



Spikes
PG-119



TSC Series

Tapered Seal

With TSC Series conical seal fittings, Nordson MEDICAL expands its range of products for small-bore connector applications in medical devices. TSC Series products offer the reliability, convenience and ease of use of luer fittings in a design that cannot be interconnected with conventional luers and avoid tubing misconnections. These luer alternatives are available in sizes to fit 1/8" (3.2 mm) and 3/16" (4.8 mm) ID flexible tubing.

Features & Benefits:

- Ergonomic grip
- Conical (tapered) seal
- 15% higher flow capacity than conventional luers
- Polypropylene resin
- Cannot interconnect with conventional luers taper fittings
- 500 Series single barbs

SMALL BORE CONNECTORS: Male

TSC2M210 (-6005)

Male Taper Seal Non-Luer Connector to 200 Series Barb, 1/16" (1.6 mm) ID Tubing



SMALL BORE CONNECTORS: Female

TSC2F210 (-6005)

Female Taper Seal Non-Luer Connector to 200 Series Barb, 1/16" (1.6 mm) ID Tubing



TSC2FB230 (-6005)

Female Taper Seal Non-Luer with 1/4-28 UNF Panel Mount to 200 Series Barb, 1/8" (3.2 mm) ID Tubing



SMALL BORE CONNECTORS: Plugs and Caps

TSC2MP (-6005) 1,000 piece minimum

Male Taper Seal Non-Luer Plug with Tether Recess



LARGE BORE CONNECTORS: Male

MLB035 (-1 -8012)

Male Large Bore Non-Luer Connector to 500 Series Barb,
3/16" (4.8 mm) ID Tubing

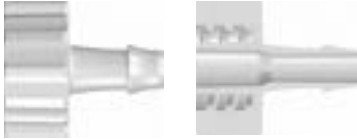

MLB055 (-1 -8012 -9)

Male Large Bore Non-Luer Connector to 500 Series Barb,
1/4" (6.4 mm) ID Tubing

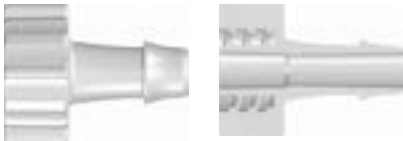

MLB065 (-8012)

Male Large Bore Non-Luer Connector to 500 Series Barb,
5/16" (8.0 mm) ID Tubing



MLBC8 (-9002)

Male Large Bore Non-Luer Connector with Integral Lock Ring to Female
Thread-Style Locking Luer

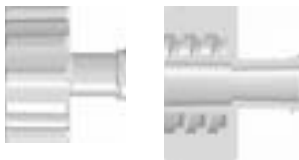

FLB035 (-1)

Female Large Bore Non-Luer Connector to 500 Series Barb,
3/16" (4.8 mm) ID Tubing

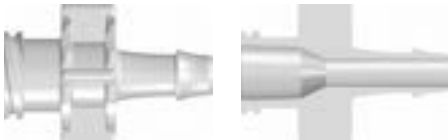

FLB055 (-1 -2 -8012)

Female Large Bore Non-Luer Connector to 500 Series Barb,
1/4" (6.4 mm) ID Tubing

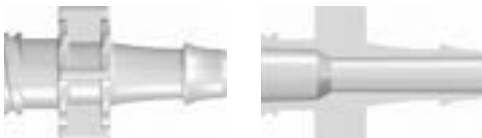

LARGE BORE CONNECTORS: Plugs and Caps

FLBP (-1 -9)

Female Large Bore Non-Luer Cap



MLBP (-1 -2 -9 -9002)

Male Large Bore Non-Luer Plug



OTHER COMPONENTS: Components

VPM2930601N (White ABS)

Tube Clamp with Split, 1/8" (3.2 mm) OD Tubing



VPS3901074N (Polyisoprene with ABA Acrylic Body)

IN-4000 Intermittent Injection Site to Male Luer Lock



VPM1060200N (Clear Low Density Polyethylene)

Long Spike Guard Closed at Tip



VPM1080303N (Blue Polyethylene)

Male Luer Integral Lock Ring Plug



VPS5069200N (White ABS Spike with Clear LDPE Guard)

Bag Spike with Vented Guard (Replaces VPS5069700N)



TECHNICAL

INFORMATION



Barb Dimensions
PG-120

Barb Performance
PG-122

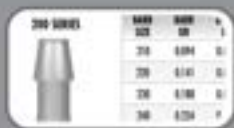

Quick Connect
Performance **PG-123**

BPF Series
Performance **PG-127**



Panel Mount
Instructions **PG-127**

Resin Information
PG-128



GENERAL	%	TEMP	TEMP	UNIT
Barb Full	75	200	250	Barb
Barb	80	200	250	Barb
Acrylonitrile	80	200	250	Barb
Acrylic	80	200	250	Barb
Al	80	200	250	Barb
Aluminum Alloy	80	200	250	Barb

Trademarks
PG-131

Index
PG-132



TECHNICAL: Barb Dimensions

The **CLASSIC SERIES** is characterized by a longer barb that extends the sealing surface of the fitting. Tubing is expanded from 42% to 69% above its nominal ID.



Barb Size	Barb OD	Barb ID	Tube Internal Diameter		
			Dec.	Frac.	Metric
10	0.105	0.046	0.063	1/16"	1.6 mm
20	0.145	0.060	0.094	3/32"	2.4 mm
30	0.187	0.078	0.125	1/8"	3.2 mm
40	0.234	0.100	0.156	5/32"	4.0 mm
50	0.280	0.130	0.188	3/16"	4.8 mm
60	0.355	0.187	0.250	1/4"	6.4 mm

The **200 SERIES** offers outstanding performance characteristics when used with flexible tubing. Tubing is expanded by 50% above its nominal ID, permitting high-pressure capabilities.



Barb Size	Barb OD	Barb ID	Tube Internal Diameter		
			Dec.	Frac.	Metric
210	0.094	0.047	0.063	1/16"	1.6 mm
220	0.141	0.070	0.094	3/32"	2.4 mm
230	0.188	0.094	0.125	1/8"	3.2 mm
240	0.234	0.117	0.156	5/32"	4.0 mm
250	0.282	0.141	0.188	3/16"	4.8 mm
260	0.375	0.188	0.250	1/4"	6.4 mm

The **300 SERIES** offers outstanding performance characteristics when used with flexible tubing. Tubing is expanded by 35% above its nominal ID, permitting high-pressure capabilities in the larger tube sizes.



Barb Size	Barb OD	Barb ID	Tube Internal Diameter		
			Dec.	Frac.	Metric
360	0.338	0.192	0.250	1/4"	6.4 mm

*Variations of barb IDs may exist. Please visit www.nordsonmedical.com to learn more about these alternatives. The data presented here is for reference only. It was compiled to provide our customers with a means of comparing the characteristics of components at the time of publication. The particular conditions of your use and application of our products are beyond our control. Thus, it is imperative that you test our products in your specific application to determine their suitability. All information is provided without implied or express warranty or guarantee by Nordson MEDICAL or other manufacturers. None of the information provided constitutes a recommendation or endorsement of any kind by Nordson MEDICAL.

The **400 SERIES** provides easy assembly while maintaining excellent pressure and tensile capabilities. Originally created for semi-rigid tubing, this series is preferred for applications where tensile/pressure properties are not highly critical, or when ease of assembly is desired. The 400 Series expands the tubing 25% above its nominal ID.



Barb Size	Barb OD	Barb ID	Tube Internal Diameter		
			Dec.	Frac.	Metric
410	0.078	0.046	0.063	1/16"	1.6 mm
420	0.117	0.068	0.094	3/32"	2.4 mm
430	0.156	0.092	0.125	1/8"	3.2 mm
440	0.206	0.125	0.156	5/32"	4.0 mm
445	0.213	0.125	0.170	-	4.3 mm
450	0.234	0.137	0.188	3/16"	4.8 mm
460	0.313	0.184	0.250	1/4"	6.4 mm

The **500 SERIES** profile is composed of blended radii, giving it the distinct look. Each barb is designed to accommodate a range of tube sizes and tube types. Consideration should be given to flow restriction, pressure capability, and the force required for assembly of the tube.



Barb Size	Barb OD	Barb ID*	Tube Internal Diameter		
			Dec.	Frac.	Metric
004	0.102	0.060	0.063	1/16"	1.6 mm
007	0.129	0.076	0.094	3/32"	2.4 mm
013	0.164	0.096	0.125	1/8"	3.2 mm
025	0.208	0.122	0.156	5/32"	4.0 mm
035	0.264	0.155	0.188	3/16"	4.8 mm
055	0.335	0.197	0.250	1/4"	6.4 mm
065	0.425	0.250	0.312	5/16"	8.0 mm
N070	0.483	0.262	0.375	3/8"	9.5 mm
L070	0.483	0.251	0.375	3/8"	9.5 mm
T070	0.483	0.290	0.375	3/8"	9.5 mm
Y070	0.483	0.290	0.375	3/8"	9.5 mm
N080	0.613	0.333	0.500	1/2"	12.7 mm
L080	0.613	0.319	0.500	1/2"	12.7 mm
T080	0.613	0.356	0.500	1/2"	12.7 mm
Y080	0.613	0.362	0.500	1/2"	12.7 mm
N090	0.718	0.390	0.625	5/8"	16.0 mm
L090	0.718	0.374	0.625	5/8"	16.0 mm
T090	0.718	0.374	0.625	5/8"	16.0 mm
Y090	0.718	0.390	0.625	5/8"	16.0 mm
N100	0.853	0.465	0.750	3/4"	19.0 mm
L100	0.853	0.443	0.750	3/4"	19.0 mm
T100	0.853	0.447	0.750	3/4"	19.0 mm
Y100	0.853	0.492	0.750	3/4"	19.0 mm
N110	1.125	0.623	1.000	1"	25.4 mm
L110	1.125	0.600	1.000	1"	25.4 mm
T110	1.125	0.600	1.000	1"	25.4 mm
Y110	1.125	0.623	1.000	1"	25.4 mm

The **600 SERIES** barbs are designed for use with silicone, C-Flex® and PVC tubing sizes commonly used in biopharm and other applications. Tubing is expanded from 18% to 34% above its nominal ID to maintain a low profile and ease of assembly, and the straight barb stem facilitates use of recommended cable tie retainers or hose clamps.



Barb Size	Barb OD	Barb ID*	Tube Internal Diameter		
			Dec.	Frac.	Metric
630	0.188	0.085	0.125	1/8"	3.2 mm
655	0.335	0.181	0.250	1/4"	6.4 mm
670	0.490	0.296	0.375	3/8"	9.5 mm
680	0.625	0.403	0.500	1/2"	12.7 mm
690	0.762	0.499	0.625	5/8"	16.0 mm
6100	0.900	0.615	0.750	3/4"	19.0 mm
6110	1.180	0.804	1.000	1"	25.4 mm

The **700 SERIES** barb is designed for use with Nordson MEDICAL's XQ Series quick connect fittings. This unique single barb is available in sizes to fit the 1/4" (6.4 mm), 5/16" (7.9 mm) and 3/8" (9.5 mm) ID tubing sizes and materials commonly used in disposable and reusable medical equipment. Reinforced PVC, unreinforced PVC and polyurethane tubing materials work well with this barb style.



Barb Size	Barb OD	Barb ID	Tube Internal Diameter		
			Dec.	Frac.	Metric
755	0.329	0.204	0.250	1/4"	6.4 mm
765	0.398	0.245	0.312	5/16"	7.9 mm
770	0.455	0.302	0.375	3/8"	9.5 mm

The **900 SERIES** offers outstanding performance characteristics when used with flexible tubing. Tubing is expanded from 8% to 17% above its nominal ID. This barb provides high flow efficiency and excellent tensile strength. A hose clamp is recommended for this series.



Barb Size	Barb OD	Barb ID	Tube Internal Diameter		
			Dec.	Frac.	Metric
970	0.437	0.269	0.375	3/8"	9.5 mm
975	0.573	0.358	0.500	1/2"	12.7 mm

Tensile pull and burst tests were performed by an independent laboratory under controlled conditions to provide comparative performance data for the various barb styles and sizes offered by Nordson MEDICAL. Graph numbers 1 through 8 present the data from each of the tests for each barb size and each barb style connected to PVC tube.

The values shown are the means of a statistically significant sample quantity of each configuration. Nordson MEDICAL barbed fittings specifically designed for use with the tubing size indicated were used in these tests. No oversized barbs, solvents, adhesives, or secondary fasteners of any kind were used.

Tensile Pull Test: Tensile properties were measured to determine the force required to remove the barbed fitting from the tubing. Tensile specimens were mounted axially in a holding fixture and tested at a rate of 20 inches per minute. Failure mode was tubing separating from the barb.

Hydrostatic Burst Test: Hydrostatic burst testing was performed in general accordance with ASTM D1599. Failure mode was either tubing separating from the barb, the tubing bursting, or a combination of the two.

Performance of Barb to Tube Connections - ■ Tensile Pull Test (lbs) - ■ Hydrostatic Burst Test (psi)

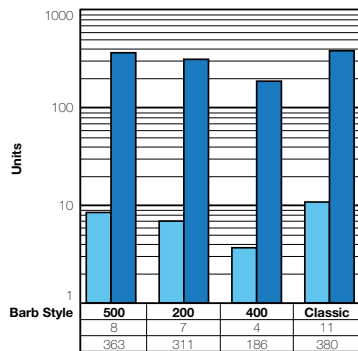

Graph 1: 1/16" Barb Performance

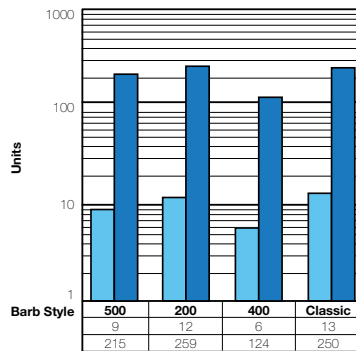

Graph 2: 3/32" Barb Performance

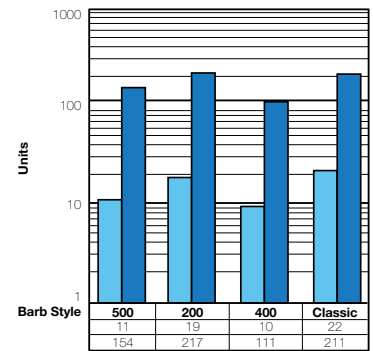

Graph 3: 1/8" Barb Performance

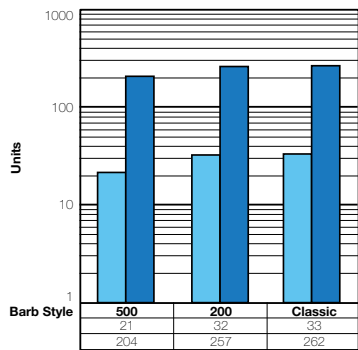

Graph 4: 5/32" Barb Performance

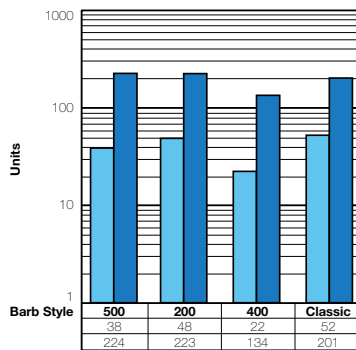

Graph 5: 3/16" Barb Performance

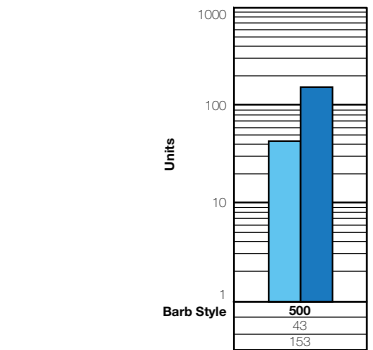

Graph 6: 1/4" Barb Performance

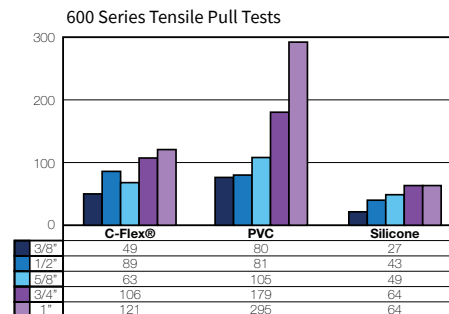
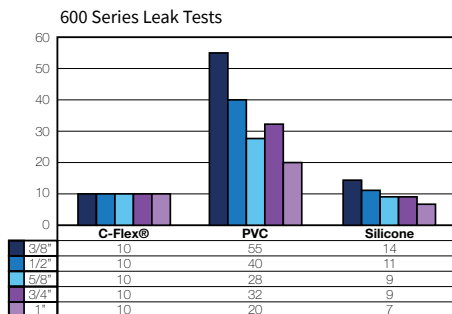

The data presented here is for reference only. It was compiled to provide our customers with a means of comparing the characteristics of components at the time of publication. The particular conditions of your use and application of our products are beyond our control. Thus, it is imperative that you test our products in your specific application to determine their suitability. All information is provided without implied or express warranty or guarantee by Nordson MEDICAL or other manufacturers. None of the information provided constitutes a recommendation or endorsement of any kind by Nordson MEDICAL.

10 SERIES - 1/16" Flow Size

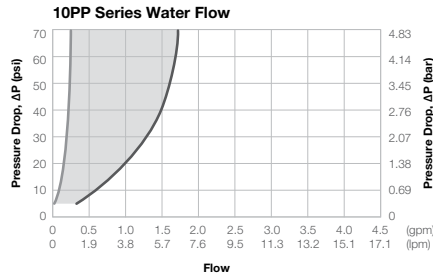
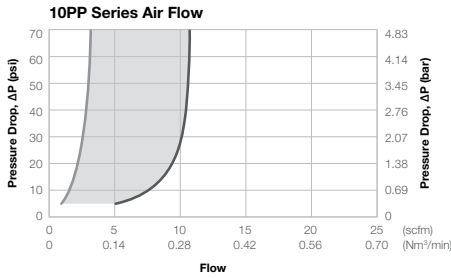
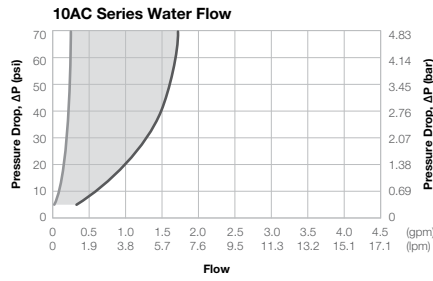
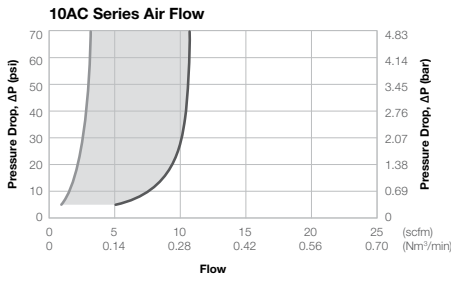

20 SERIES - 1/8" Flow Size

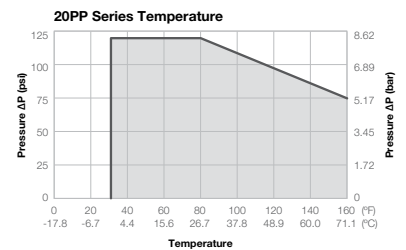
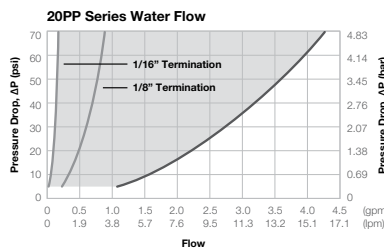
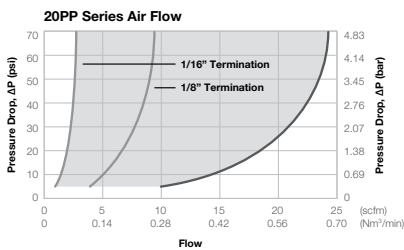
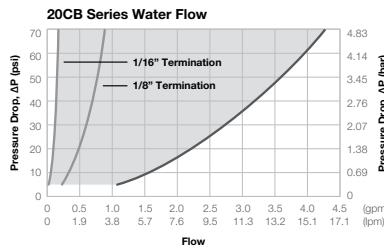
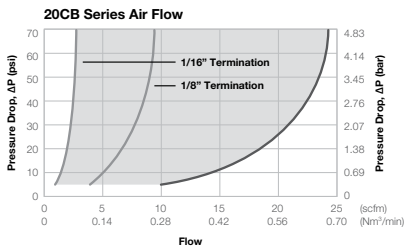
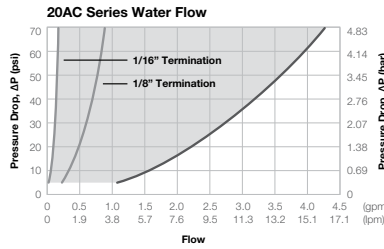
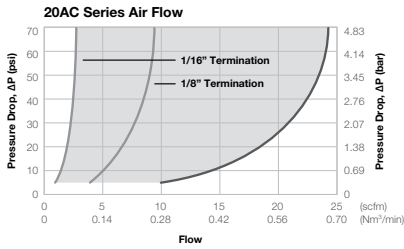

30 SERIES - 1/8" Flow Size

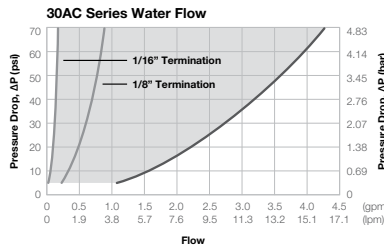
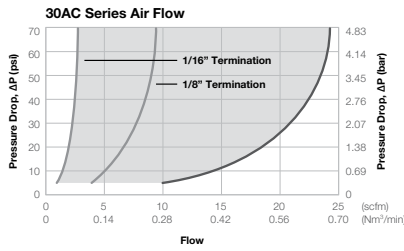

40 SERIES - 1/4" Flow Size

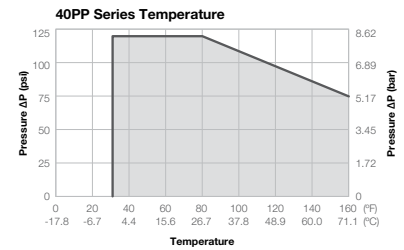
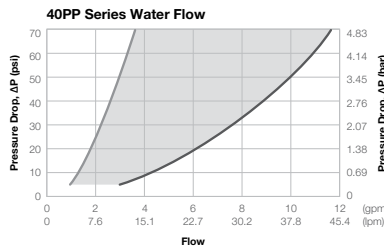
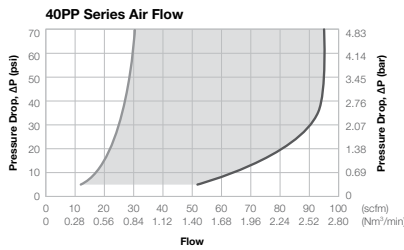
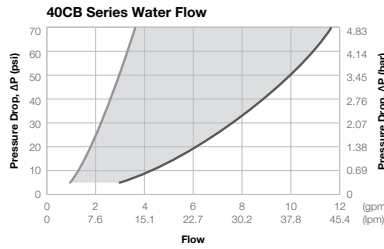
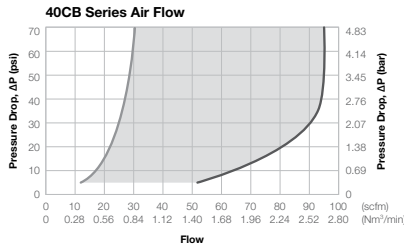
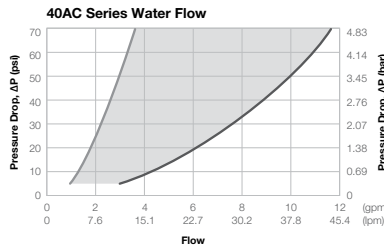
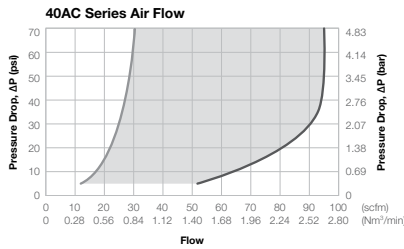

42 SERIES - 3/32" Flow Size

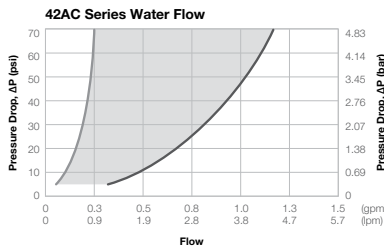
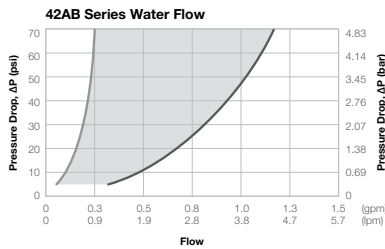

The data presented here is for reference only. It was compiled to provide our customers with a means of comparing the characteristics of components at the time of publication. The particular conditions of your use and application of our products are beyond our control. Thus, it is imperative that you test our products in your specific application to determine their suitability. All information is provided without implied or express warranty or guarantee by Nordson MEDICAL or other manufacturers. None of the information provided constitutes a recommendation or endorsement of any kind by Nordson MEDICAL.

50 SERIES - 1/4" Flow Size

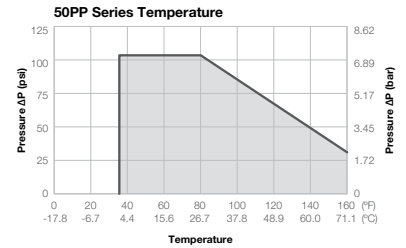
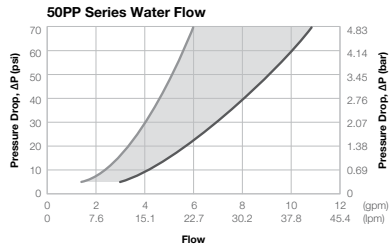
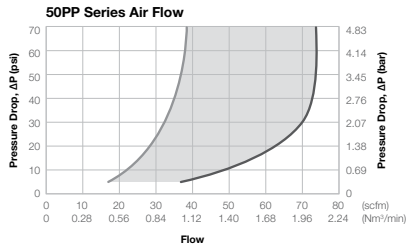
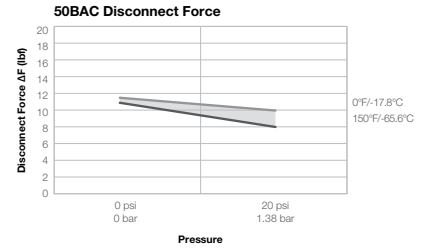
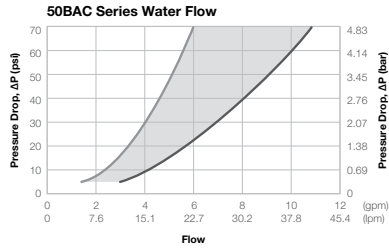
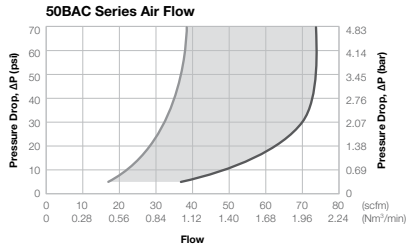
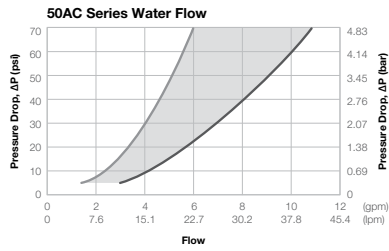
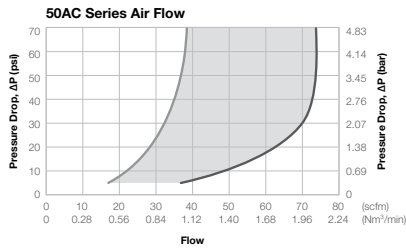

55 SERIES - 1/8" - 1/4" Flow Size

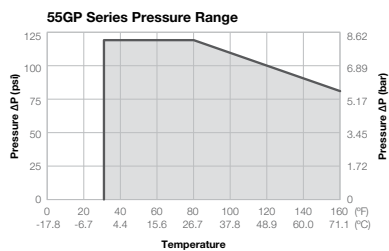
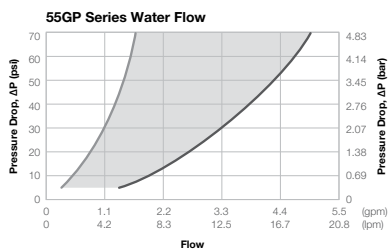

60 SERIES - 3/8" Flow Size

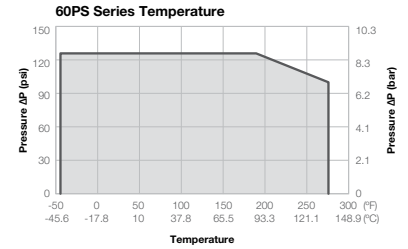
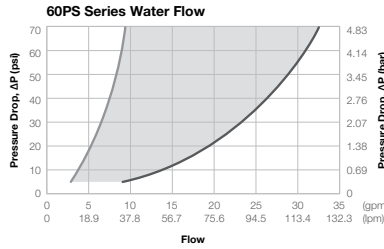
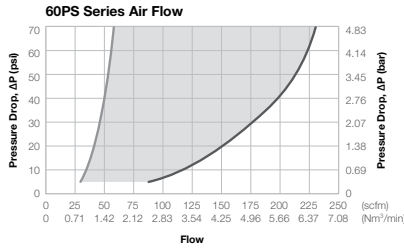
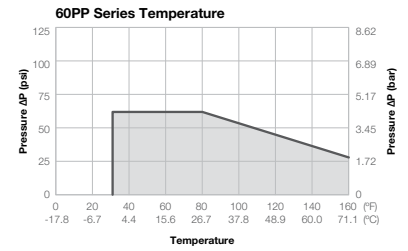
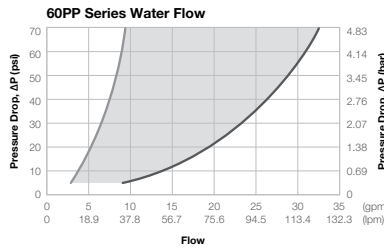
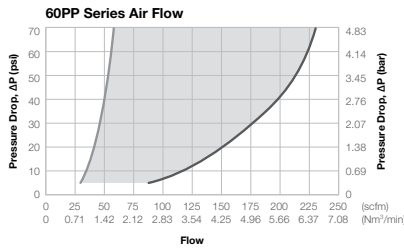

65 SERIES - 1/2" Flow Size

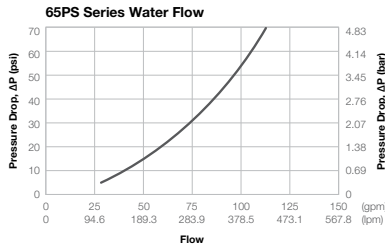

70 SERIES - 1/4" Flow Size

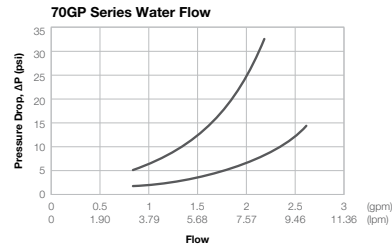

100 SERIES - 1/16" Flow Size

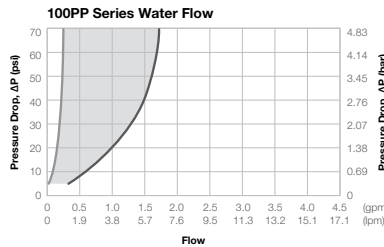
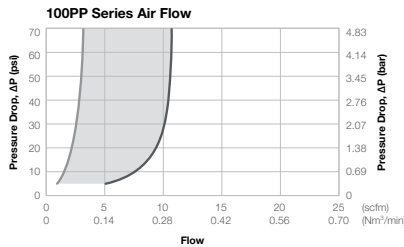
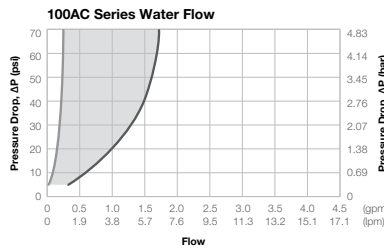
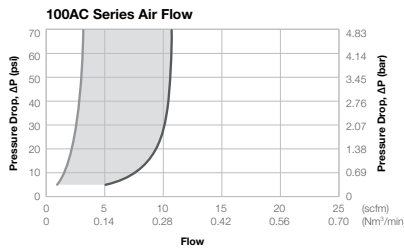

The data presented here is for reference only. It was compiled to provide our customers with a means of comparing the characteristics of components at the time of publication. The particular conditions of your use and application of our products are beyond our control. Thus, it is imperative that you test our products in your specific application to determine their suitability. All information is provided without implied or express warranty or guarantee by Nordson MEDICAL or other manufacturers. None of the information provided constitutes a recommendation or endorsement of any kind by Nordson MEDICAL.

Maximum cycles _____ 50,000 connect-disconnect cycles

Maximum leak resistance _____ < .007 psi / 0.05 kPa / sec.

Maximum axial tensile resistance _____ 20 lbf.

Minimum Fitting ID _____ .113" / 2.9 mm

Maximum working pressure _____ 60 psi, 4.14 bar

Minimum Cv _____ .39

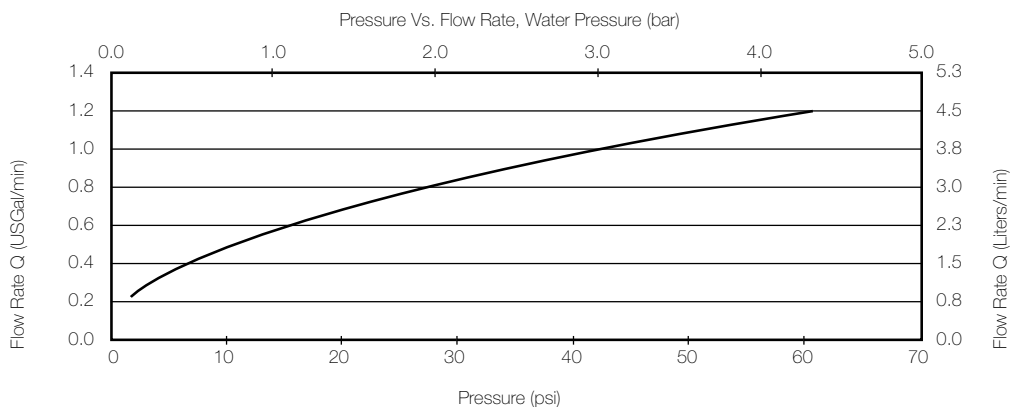

TECHNICAL:
Panel Mount Instructions

Panel-mounted female luers, in both FTLLB (thread style) and FTLB (lug style) series, are shown beginning on page 18. When used with our CCLR lock rings or CCR color coding rings and LNS lock nuts (see pages 19, 31), color coding of connections is easy.

The information provided here will help you mount the panel mount luers. Please note that they are intended for panel thickness of 1/16" to 1/8" (1.5 to 3 mm).

FTLLB series shown with MLSL luer, FSLLR lock ring, CCLR color coding lock ring, and LNS lock nut.

Threaded Panel Openings: Tap the panel with threads from tube fittings, panel mounts or BPMBs and use a CCR color coded ring. In this case, the fitting tightened into the panel prevents fitting rotation. Use an LNS lock nut for additional security; tighten snug plus 1/4 turn only.

Non-Threaded Panel Openings: Use any one of the three panel patterns shown below with a CCLR lock ring and LNS lock nut. Together, the panel opening and CCLR prevent the panel mount fitting from rotating. Tighten LNS snug plus 1/4 turn only.

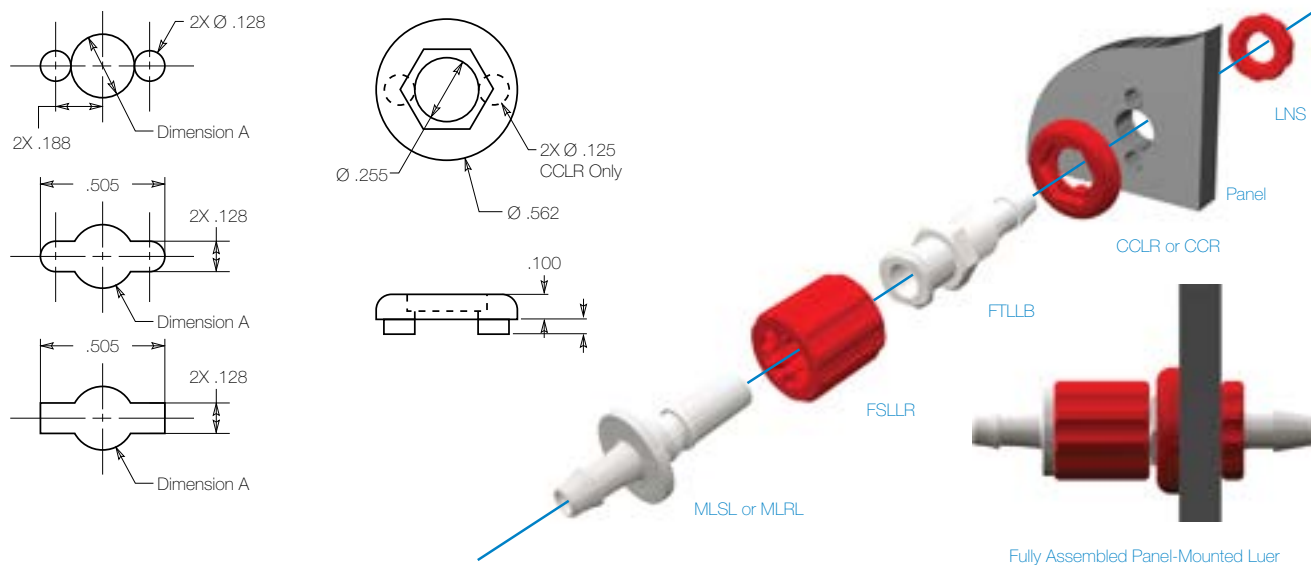

CHEMICAL	%	TEMP C	TEMP F	ABS	ACETAL	PVDF	NYLON	POLYCARBONATE	POLYPROPYLENE	POLYSULFONE
Acetic Acid	5%	23 C	73 F	Excellent	Unsatisfactory	Excellent	Satisfactory	Satisfactory	Excellent	Excellent
Acetone	100%	50 C	122 F	Unsatisfactory	Unsatisfactory	Unsatisfactory	Satisfactory	Unsatisfactory	Excellent	Unsatisfactory
Acetophenone	100%	24 C	75 F	Satisfactory	—	Unsatisfactory	Excellent	—	Satisfactory	—
Acetylene	100%	24 C	75 F	—	—	Excellent	Excellent	—	—	—
Air	100%	82 C	180 F	Excellent	Excellent	Excellent	Excellent	—	—	Excellent
Ammonia, Liquid	100%	24 C	75 F	Satisfactory	—	Unsatisfactory	Satisfactory	Unsatisfactory	Excellent	Excellent
Ammonium Hydroxide	10%	23 C	73 F	Satisfactory	—	Excellent	Excellent	Unsatisfactory	Excellent	Excellent
Ammonium Hydroxide	10%	70 C	158 F	Unsatisfactory	—	Excellent	Unsatisfactory	Unsatisfactory	Excellent	Excellent
Barium Sulfide	100%	24 C	75 F	Excellent	Excellent	Excellent	Satisfactory	—	Excellent	—
Benzene	100%	23 C	73 F	Satisfactory	Excellent	Excellent	Excellent	Unsatisfactory	Satisfactory	Unsatisfactory
Bleach	100%	23 C	73 F	—	Unsatisfactory	Excellent	Satisfactory	Unsatisfactory	Satisfactory	Excellent
Boric Acid	7%	35 C	95 F	Excellent	Excellent	Excellent	Unsatisfactory	Excellent	Excellent	—
Calcium Carbonate	Sat. sol.	24 C	75 F	Excellent	—	Excellent	—	—	Excellent	—
Carbon Dioxide	100%	50 C	122 F	Satisfactory	Excellent	Excellent	Excellent	—	Excellent	—
Carbon Monoxide	100%	50 C	122 F	Satisfactory	—	Excellent	Excellent	—	Excellent	—
Carbon Tetrachloride	100%	50 C	122 F	Unsatisfactory	—	Excellent	Excellent	Unsatisfactory	Unsatisfactory	Unsatisfactory
Chlorine Water	Dilute	23 C	73 F	Unsatisfactory	—	Excellent	Satisfactory	Unsatisfactory	Unsatisfactory	Satisfactory
Chlorine Water	Concen.	23 C	73 F	Unsatisfactory	—	Excellent	Unsatisfactory	Unsatisfactory	Unsatisfactory	Unsatisfactory
Chlorobenzene	100%	23 C	73 F	Satisfactory	—	Excellent	Excellent	Unsatisfactory	Unsatisfactory	Unsatisfactory
Chlorofluorocarbon 11	100%	24 C	75 F	—	—	Excellent	Excellent	Satisfactory	—	Excellent
Chloroform	100%	23 C	73 F	Unsatisfactory	Satisfactory	Excellent	Satisfactory	Unsatisfactory	Unsatisfactory	Unsatisfactory
Cyclohexanone	100%	24 C	75 F	Unsatisfactory	—	Excellent	Excellent	Unsatisfactory	Satisfactory	Unsatisfactory
Dichlorethylene	100%	23 C	73 F	—	—	Excellent	Satisfactory	—	Excellent	Unsatisfactory
Ethanol	95%	50 C	122 F	Satisfactory	—	Excellent	Excellent	Satisfactory	Excellent	Satisfactory
Ethyl Acetate	95%	50 C	122 F	Satisfactory	—	Unsatisfactory	Excellent	Unsatisfactory	Satisfactory	Unsatisfactory
Ethylene Glycol	100%	23 C	73 F	Excellent	Satisfactory	Excellent	Excellent	Satisfactory	Excellent	Excellent
Ethylene Oxide	100%	24 C	75 F	Unsatisfactory	—	Excellent	Satisfactory	Satisfactory	Satisfactory	Excellent
Ethylene Oxide	100%	79 C	175 F	Unsatisfactory	—	Excellent	Unsatisfactory	Satisfactory	Unsatisfactory	Excellent
Fatty Acids	—	—	—	—	Excellent	Excellent	—	Satisfactory	Excellent	—
Fluorine	100%	23 C	73 F	Unsatisfactory	—	Excellent	Unsatisfactory	—	—	—
Formaldehyde	37%	24 C	75 F	Unsatisfactory	Excellent	Excellent	—	Unsatisfactory	Excellent	Unsatisfactory
Gasoline	100%	85 C	185 F	Excellent	Satisfactory	Excellent	Excellent	Unsatisfactory	Satisfactory	Satisfactory
Glucose	Concen.	24 C	75 F	Excellent	—	Excellent	—	—	Excellent	—
Glycerin	100%	24 C	75 F	Excellent	—	Excellent	—	Excellent	Excellent	Excellent
Hydrochloric Acid	2%	23 C	73 F	Excellent	Satisfactory	Excellent	Excellent	Excellent	Excellent	Excellent
Hydrochloric Acid	10%	25 C	77 F	Excellent	Satisfactory	Excellent	Unsatisfactory	Excellent	Excellent	Excellent
Hydrofluoric Acid	10%	23 C	73 F	Satisfactory	—	Excellent	Unsatisfactory	—	Excellent	Excellent
Hydrogen Peroxide	1%	24 C	75 F	Excellent	Unsatisfactory	Excellent	Satisfactory	Excellent	Excellent	Excellent
Hydrogen Peroxide	5%	43 C	110 F	Satisfactory	Unsatisfactory	Excellent	Unsatisfactory	Excellent	Satisfactory	Excellent
Isopropanol	70%	23 C	73 F	—	Excellent	Excellent	Excellent	Call*	Excellent	Satisfactory
Kerosene	100%	85 C	185 F	Satisfactory	—	Excellent	Excellent	Satisfactory	Satisfactory	Satisfactory
Methyl Ethyl Ketone	100%	50 C	122 F	Unsatisfactory	—	Unsatisfactory	Excellent	Unsatisfactory	Satisfactory	Unsatisfactory
Methylene Chloride	100%	23 C	73 F	Unsatisfactory	—	Excellent	Satisfactory	Unsatisfactory	Excellent	Unsatisfactory
Methanol	100%	23 C	73 F	Unsatisfactory	—	Excellent	Excellent	Satisfactory	Excellent	Satisfactory
Nitric Acid	10%	23 C	73 F	Satisfactory	—	Excellent	Unsatisfactory	Unsatisfactory	Excellent	Satisfactory
Oxygen	100%	24 C	75 F	—	—	Excellent	Satisfactory	—	—	—
Ozone	100%	43 C	110 F	Satisfactory	—	Satisfactory	Unsatisfactory	Unsatisfactory	—	—
Phenol	90%	23 C	73 F	Unsatisfactory	Unsatisfactory	Excellent	Unsatisfactory	—	Excellent	—
Phosphoric Acid	5%	98 C	208 F	Satisfactory	Unsatisfactory	Excellent	Unsatisfactory	Unsatisfactory	Excellent	Excellent
Propane	100%	23 C	73 F	Satisfactory	—	Excellent	Excellent	—	—	—
Sodium Bicarbonate	Concen.	24 C	75 F	Excellent	Excellent	Excellent	Excellent	—	Excellent	Excellent
Sodium Chloride	10%	23 C	73 F	Excellent	—	Excellent	Excellent	—	Excellent	Excellent
Sodium Chloride	Sat. sol.	24 C	75 F	Excellent	—	Excellent	Excellent	—	Excellent	Excellent
Sodium Hydroxide	10%	70 C	158 F	Satisfactory	—	Excellent	Satisfactory	—	Excellent	Excellent
Steam	—	120 C	248 F	Unsatisfactory	—	Excellent	Unsatisfactory	Unsatisfactory	Satisfactory	Excellent
Sulfuric Acid	30%	23 C	73 F	Satisfactory	Unsatisfactory	Excellent	Unsatisfactory	Excellent	Excellent	Excellent
Tetrahydrofuran	100%	23 C	73 F	Satisfactory	—	Unsatisfactory	Excellent	—	Unsatisfactory	—
Toluene	100%	50 C	122 F	Satisfactory	Unsatisfactory	Excellent	Excellent	Unsatisfactory	Unsatisfactory	Unsatisfactory
Trichloroethylene	100%	23 C	73 F	Satisfactory	—	Excellent	Satisfactory	Unsatisfactory	Unsatisfactory	Unsatisfactory
Water	100%	79 C	175 F	Excellent	—	Excellent	Excellent	Unsatisfactory	Excellent	Excellent

* Polycarbonate is known to experience environmental stress cracking when exposed to solvents. Please contact Nordson MEDICAL technical support if polycarbonate is planning on being used in a solvent bonding application. Looking for a stress-free connection? Ask our technical experts at 1-888-404-5837 how annealing and other secondary processes can alleviate the risk of environmental stress cracking in polycarbonate materials.

The data presented here is for reference only. It was compiled to provide our customers with a means of comparing the characteristics of components at the time of publication. The particular conditions of your use and application of our products are beyond our control. Thus, it is imperative that you test our products in your specific application to determine their suitability. All information is provided without implied or express warranty or guarantee by Nordson MEDICAL or other manufacturers. None of the information provided constitutes a recommendation or endorsement of any kind by Nordson MEDICAL.

Material - Manufacturer & Grade	VP Code	Regulatory Compliance of Base Resin*	RoHS Compliant	BPA Free	DEHP Free	Animal Derivative Free*
ABS (Lace White) - INEOS Lustran 348-000000	-81	USP Class VI Certified; ISO 10993 Part I Compliant	Yes	Yes	Yes	No
ABS, MABS (Methyl Methacrylate) - BASF Terluc 2802 HD	SCV Series	USP Class VI Certified	Yes	Yes	Yes	No
ABS, MABS (Methyl Methacrylate) - BASF Terluc 2802 TR	-8003	General Purpose	Yes	Yes	Yes	No
ABS (Sno White) - INEOS Lustran 348-012002	-8012	USP Class VI Certified; ISO 10993 Part I Compliant	Yes	Yes	Yes	No
Acetal - DuPont Delrin 500P	-10	21 CFR 177.2480 FDA Approved	Yes	Yes	Yes	No
Acetal Copolymer - BASF Ultraform N 23020.003	-1006, -1007	21 CFR 177.2470 FDA Approved	Yes	Yes	Yes	No
Acrylic - Cyro Cyrolite Med 2	-50	USP Class VI Certified; ISO 10993 Compliant; 21 CFR 177.1010 FDA Approved	Yes	Yes	Yes	Yes
Nylon (PA 66) - DuPont Zytel 101F	-0, -1, -2, -3, -4, -5, -06, -07, -08B, -8, -8B, -CM030	21 CFR 177.1500 FDA Approved	Yes	Yes	Yes	No
Nylon (PA 66) - DuPont Zytel SC310 NC010	-U1, -U5, -U01, -U05	USP Class VI Certified; ISO 10993 Compliant; 21 CFR 177.1500 FDA Approved	Yes	Yes	Yes	No
Nylon (Glass Reinforced) - DuPont Zytel FGFE5171	-U71, -U75	USP Class VI Certified; ISO 10993 Compliant; 21 CFR 177.1500 FDA Approved	Yes	Yes	Yes	No
Nylon (Glass Reinforced) - DuPont Zytel 70G33L	-7, -72	21 CFR 177.1500 FDA Approved	Yes	Yes	Yes	No
Polycarbonate (Clear) - Bayer Makrolon 2558 550115	-9	USP Class VI Certified; ISO 10993 Compliant; 21 CFR 177.1580 FDA Approved	Yes	No	Yes	No
Polycarbonate (Clear) - Bayer Makrolon Rx 1805 451118	-9010, SCV Series	USP Class VI Certified; ISO 10993 Compliant	Yes	No	Yes	Yes
Polycarbonate (Tinted) - Sabic Lexan HPS1	-9024	USP Class VI Certified; ISO 10993 Compliant	Yes	No	Yes	No
Polycarbonate (Tinted) - Styron Calibre Megarad 2081-15	-9002, DCV Series	ISO 10993 Compliant	Yes	No	Yes	No
Polyethylene - LyondellBase ll Purell PE 1840 H	SCV Series	Please call for details	Yes	Yes	Yes	Yes
Polyethylene - Trilliant HC5420-0002 LL Natural Resin	-VP1	USP Class VI Certified	Yes	Yes	Yes	Yes
Polyketone - Hyosung CS1826-CS8B382PK (M330F Preco)	-PK5	USP Class VI Certified; ISO 10993 Compliant	Yes	Yes	Yes	Yes
Polypropylene - Flint Hills PSM6K-080	-6005, -6006	USP Class VI Certified; 21 CFR 177.1520 FDA Approved	Yes	Yes	Yes	Yes
Polysulfone - Solvay Udel P1700 CL2611	-40	USP Class VI Certified; ISO 10993 Compliant; 21 CFR 177.1655 FDA Approved	Yes	Yes	Yes	Yes
PVDF - Arkema Kynar 1000 HD	-J2A	USP Class VI Certified; 21 CFR 177.2510 FDA Approved	Yes	Yes	Yes	Yes
SAN - BASF 388S TR 77770	SCV Series	ISO 10993 Compliant	Yes	Yes	Yes	No
Silicone - Wacker Elastosil LR 3003	SCV Series	USP Class VI Certified	Yes	Yes	Yes	Yes

*As determined by resin manufacturer

Material - Manufacturer & Grade	VP Code	Gamma Radiation Sterilization*	Ethylene Oxide Sterilization	Autoclave Sterilization
ABS (Iace White) - INEOS Lustran 348-000000	-81	Compatible up to 5 Mrads	Good	Not suitable due to low heat deflection temperatures
ABS, MABS (Methyl Methacrylate) - BASF Terlux 2802 TR/HD	-8003, SCV Series	Withstands up to 5 Mrad doses without yellowing	Good	Poor; components may distort due to low heat deflection temperatures
ABS (Sno White) - INEOS Lustran 348-012002	-8012	Compatible up to 5 Mrads	Good	Not suitable due to low heat deflection temperatures
Acetal - DuPont Delrin 500P	-10	Compatible up to 1 Mrad	Excellent	Very good
Acetal Copolymer - BASF Ultraform N2320 003	-1006, -1007	Compatible up to 1.5 Mrads	Excellent	Very good
Acrylic - Cyro Cyrolite Med 2	-50	Very good up to commonly used doses (6 Mrads)	Excellent	Not recommended
Nylon (PA 66) - DuPont Zytel 101F	-0, -1, -2, -3, -4, -5, -06, -07	Very good; may discolor to brownish hue	Very good; some susceptibility to oxidizing agents	Very good; product may swell slightly due to water absorption
Nylon (Glass Reinforced) - DuPont Zytel FGF E3171	-U71, -U75	Very good; may discolor to brownish hue	Very good; some susceptibility to oxidizing agents	Excellent
Polycarbonate (Clear) - Bayer Makrolon 2558 550115	-9	Compatible up to 10 Mrads with minor loss of physical properties; will discolor to yellow-green hue	Highly compatible	Poor; may craze or stress crack due to molding stresses
Polycarbonate (Clear) - Bayer Makrolon Rx 1805 451118	-9010, SCV Series	Compatible up to 10 Mrads with minor loss of physical properties; may discolor slightly dependent upon dose/number of cycles	Highly compatible	Poor; may craze or stress crack due to molding stresses
Polycarbonate (Clear, Tinted) - Covestro Makrolon 3158	-9021, -9026, FC Series	Compatible up to 5 Mrads; clear may slightly discolor at higher doses	Highly compatible	No data
Polycarbonate (Tinted) - Sabic Lexan HPS1	-9024	Highly compatible with reduced color shift when compared to unstabilized polycarbonate resins	Highly compatible	Not recommended
Polycarbonate (Tinted) - Styron Calibre Megarad 2081-15	-9002, DCV Series	Excellent up to 10 Mrads with minor loss of physical properties; light violet hue turns clear upon sterilization	Highly compatible	Not recommended
Polyethylene - INEOS T60-800-119	-30, FC Series	Compatible up to 5 Mrads	Highly compatible	No data
Polyethylene - LyondellBasell Purrell PE 1840 H	SCV Series	Compatible up to 5 Mrads	Highly compatible	Not recommended
Polyethylene - Trilliant HC5420-0002 LL Natural Resin	-VP1	Highly compatible	Highly compatible	Not recommended
Polyketone - Hysung CS1826-CS88382PK (M330F Preco)	-PK5	Compatible up to 50 Kg	Highly compatible	Excellent
Polypropylene - Flint Hills P5M6K-080	-6005, -6006, -6012	Very good to commonly used sterilization doses (6 Mrads)	Highly compatible	Limited to 121 °C for 20 minutes due to low heat deflection temperatures
Polysulfone - Solvay Udel P1700 CL2611	-40	Highly compatible; will discolor to brownish hue	Excellent	Excellent
PVDF - Arkema Kynar 740 Natural	-J2A	Highly compatible; will discolor to brownish hue	Excellent	Highly compatible
SAN - BASF 388S TR 77770	SCV Series	Compatible up to 5 Mrads	Good	Not suitable due to low heat deflection temperatures
Silicone - Wacker Elastosil LR 3003	SCV Series	Compatible up to 5 Mrads	Highly compatible	Very good

*** 1 Megarad (Mrad) = 10 kilograys (kGy)**

Property	ASTM Test Method	PVDF	Polycarb	Radiation Stable PC	Polypro	Nylona	GF Nylona	ABS	MABS	Polysulfone	Acetal
Tensile Strength	D638	5,400	10,000	9,800	—	12,000	27,000	4,800	—	—	—
Elongation at Break, %	D638	100-400	120	150	375	300	3	50	12	50-100	40
Tensile Yield Strength, psi	D638	6,500	9,200	9,800	4,400	12,000	—	5,700	6,960	10,200	9,900
Flexural Modulus, kpsi	D790	360	330	350	170	410	1,300	330	—	390	450
Rockwell Hardness D	D785	—	R118	R118	R80-102	R121	—	R107	—	—	R122
Rockwell Hardness M	—	—	M75	M72	—	M79	M101	—	—	M69	M89
Shore Hardness D	D2240	D76-80	—	—	—	—	—	—	—	—	—
Coef. of Linear 10-5 in/in/°F	D696	7.6	3.9	3.8	—	4	1.3	5.5	—	3.1	—
Deflection Temp°F @264psi	D648	244	266	252	—	194	480	173	194	345	216
Deflection Temp°F @66psi	D648	—	273	—	190	455	—	—	201	358	332
Water Absorption, %, 24 h	D570	0.015	0.15	0.15	0	1.2	0.7	0.25-0.40	0.7	0.3	0.4
Izod Impact, (Notched) ft-lb/in	D256	3.1	16.0	14.0	0.5	1.0	2.2	6.0	1.31	1.3	—

The data presented here is for reference only. It was compiled to provide our customers with a means of comparing the characteristics of components at the time of publication. The particular conditions of your use and application of our products are beyond our control. Thus, it is imperative that you test our products in your specific application to determine their suitability. All information is provided without implied or express warranty or guarantee by Nordson MEDICAL or other manufacturers. None of the information provided constitutes a recommendation or endorsement of any kind by Nordson MEDICAL.

TECHNICAL:
Trademarks

Trademark **1,428,380**



Corporate Trademark. The stylized design associated with Value Plastics' products and services.

To protect our intellectual property and our customers, it is important to be aware of the patents and trademarks that apply to our products. Look for the Value Plastics logo (∞) to ensure you do not mistakenly use a poor quality counterfeit of a Value Plastics fitting, thereby jeopardizing the integrity and quality of your product.

- BioClamp® is a registered trademark of BioPure Technology Ltd.
- BioValve® is a registered trademark of BioPure Technology Ltd.
- C-Flex® is a registered trademark of Consolidated Polymer Technologies, Inc.
- CYROLITE® Protect is a registered trademark of Evonik Corporation
- Dinamap® is a registered trademark of GE Healthcare
- Equistar® is a registered trademark of Equistar Chemicals
- Kynar® is a registered trademark of Atochem Atofina North America, Inc.
- Lubrizol® is a registered trademark of The Lubrizol Corporation
- Teknor® is a registered trademark of Teknor Apex Company
- Tuf-Flex® is a registered trademark of Rubber Fab Technologies Group

Trademark **1,887,178**

Value Plastics®

Corporate Trademark.

One or more components contained in this catalog may be covered by B. Braun OEM Division patents and trademarks. Patent numbers: 4,246,932; 4,535,820; 4,683,916.

Trademark **3,838,623**

BUILD-A-PART®

Trademark for our non-metal bondable fittings

©2024 Nordson MEDICAL. All rights reserved. No part of this catalog may be reproduced without the express consent of Nordson MEDICAL. All terms are current as of January, 2024 and are subject to change without notice.

OTHER TRADEMARKS

- 1,827,467
- 1,817,921
- 1,817,922
- 2,655,263
- 2,616,170
- 2,535,232
- 2,535,234

3PF210	29	14MTLL	17	20ACV-SB1-02	41
3PF220	29	18FTLL	18	20ACV-SB1-02BSPT	41
3PF230	29	18L230	111	20ACV-SB1-02UT	41
4PDL220	29	18L250	111	20ACV-SB1-04	41
4PLL210	29	18L260	111	20ACV-SB1-04BSPT	41
4PLL220	29	18LFTLL	18	20ACV-SB2-01	41
4PLL230	29	18MTLL	17	20ACV-SB2-02	41
4PX210	29	18T260	111	20ACV-SB2-03	41
4PX220	29	20AC-PB1-02	39	20ACV-SB2-04	41
4PX230	29	20AC-PB1-02BSPT	39	20ACV-SB3-01	43
4PX655	99	20AC-PB2-01	39	20ACV-SB3-01GS	43
4PX670	99	20AC-PB2-02	39	20ACV-SB3-02	43
4PX670/655	99	20AC-PB2-03	39	20ACV-SB3-02GS	43
4PX680	99	20AC-PB2-04	39	20ACV-SB3-03	43
4PX680/670	99	20AC-PB3-02	40	20ACV-SB3-03GS	43
4PX6100	99	20AC-PB3-03	40	20ACV-SB3-04	43
4PX6110	99	20AC-PB4-02	41	20ACV-SB3-04GS	43
4PX6110/6100	99	20AC-PB4-04	41	20ACV-SB4-02	44
6PDT220	29	20AC-PB9-04	39	20ACV-SB4-04	44
6PDT230	29	20AC-S1-02	38	20ACV-SB8-04	43
6PTT230	29	20AC-S1-02BSPT	38	20ACV-SB8-04GS	43
10AC2-02BLK	38	20AC-S1-04	38	20ACV-SB8-025	43
10AC2-M3BLK	38	20AC-S2-02	38	20ACV-SB9-04	41
10AC-PB2-01	37	20AC-S2-03	38	20ACV-SB10-04	44
10AC-PB2-02	37	20AC-S2-04	38	20CB-PB1-02	39
10AC-PB2-02BLK	37	20AC-S3-01	40	20CB-PB1-04	39
10AC-PB2-M3	37	20AC-S3-02	40	20CB-PB1-04BSPT	39
10AC-PB3-02	37	20AC-S3-03	40	20CB-PB3-02	40
10AC-PB3-M3	37	20AC-S3-03GS	40	20CB-PB4-02	41
10AC-PB3-M3BLK	37	20AC-S3-04	40	20CB-PB4-04	41
10AC-S2-02	36	20AC-S4-04	40	20CB-PB9-04	39
10AC-S2-02BLK	36	20AC-S8-04	40	20CB-S1-02	38
10AC-S2-02NSBLK	36	20AC-S8-025	40	20CB-S1-02BSPT	38
10AC-S2-M3BLK	36	20AC-S9-04	38	20CB-S3-02	40
10AC-S3-01	37	20ACV-PB1-02	42	20CB-S8-04	40
10AC-S3-02	37	20ACV-PB1-02BSPT	42	20CB-S9-04	38
10ACV-SB2-01NSBLK	37	20ACV-PB1-04	42	20CB-S9-025	38
10ACV-SB2-02	37	20ACV-PB1-04BSPT	42	20CBV-PB2-02	42
10ACV-SB2-M3	37	20ACV-PB2-01	42	20CBV-PB2-04	42
10ACV-SB2-M3BLK	37	20ACV-PB2-02	42	20CBV-PB3-02	44
10ACV-SB2-M3NSBLK	37	20ACV-PB2-03	42	20CBV-PB3-03	44
10ACV-SB3-01	38	20ACV-PB2-04	42	20CBV-PB3-04	44
10ACV-SB3-02	38	20ACV-PB3-01	44	20CBV-PB8-04	44
10ACV-SB3-M3BLK	38	20ACV-PB3-02	44	20CBV-PB9-04	42
10PP-PE2-01	37	20ACV-PB3-03	44	20CBV-PB9-025	42
10PP-PE2-M3NS	37	20ACV-PB3-04	44	20CBV-PB10-04	44
10PP-PE3-01	37	20ACV-PB4-02	44	20CBV-SB1-02	41
10PP-S2-01	36	20ACV-PB4-04	44	20CBV-SB1-02BSPT	41
10PP-S2-M3NS	36	20ACV-PB8-04	44	20CBV-SB1-04	41
10PP-S3-01	37	20ACV-PB9-04	42	20CBV-SB2-02	41
10PP-S3-M3	37	20ACV-PB9-025	42	20CBV-SB2-03	41

20CBV-SB2-04.....	41	30AC-S2-04.....	45	40ACV-SB3-06.....	49
20CBV-SB3-02.....	43	30ACV-PB2-02.....	45	40ACV-SB8-04.....	49
20CBV-SB8-04.....	43	30ACV-PB2-04.....	45	40ACV-SB8-06.....	49
20CBV-SB19-1032.....	43	30ACV-PB10-04.....	45	40ACV-SB9-04.....	48
20PP-PE2-01MALD.....	39	30ACV-SB2-02.....	45	40ACV-SB9-06.....	48
20PP-PE2-02.....	39	30ACV-SB2-04.....	45	40ACV-SB18-04.....	49
20PP-PE2-02MALD.....	39	30ACV-SB9-04.....	45	40CB-PB1-04.....	46
20PP-PE2-04.....	39	30ACX-PB1-04.....	45	40CB-PB2-06.....	46
20PP-S1-02.....	39	33PCV-SPS2-02.....	45	40CB-PB10-04.....	47
20PP-S1-04.....	39	40AC-PB1-04.....	46	40CB-S1-04.....	46
20PP-S2-02.....	39	40AC-PB2-04.....	46	40CB-S1-04BSPT.....	46
20PP-S2-04.....	39	40AC-PB2-05.....	46	40CB-S2-04.....	46
20PP-S3-02.....	40	40AC-PB2-06.....	46	40CB-S8-04.....	47
20PP-S3-02MALD.....	40	40AC-PB3-04.....	47	40CB-S12-04.....	47
20PP-S3-04.....	40	40AC-PB3-06.....	47	40CB-S3557.....	64
20PP-S3-04MALD.....	40	40AC-PB4-04.....	47	40CB-S3559.....	64
20PP-S8-025MALD.....	40	40AC-PB4-06.....	47	40CB-S35271.....	64
20PPV-PE1-02.....	42	40AC-PB8-06.....	47	40CB-S35288.....	64
20PPV-PE1-02MALD.....	42	40AC-S1-04.....	46	40CB-S35296.....	64
20PPV-PE2-01.....	42	40AC-S1-04BSPT.....	46	40CBV-P75242.....	64
20PPV-PE2-01MALD.....	42	40AC-S1-06.....	46	40CBV-PB1-04.....	49
20PPV-PE2-02.....	42	40AC-S1-06BLK.....	46	40CBV-PB1-04BSPT.....	49
20PPV-PE2-02MALD.....	42	40AC-S2-04.....	46	40CBV-PB2-04.....	49
20PPV-PE2-04.....	42	40AC-S2-05.....	46	40CBV-PB2-05.....	49
20PPV-PE2-04MALD.....	42	40AC-S2-06.....	46	40CBV-PB2-06.....	49
20PPV-PE4-02.....	44	40AC-S3-04.....	47	40CBV-PB3-04.....	50
20PPV-PE4-02MALD.....	44	40AC-S3-06.....	47	40CBV-PB3-06.....	50
20PPV-PE4-04.....	44	40AC-S8-04.....	47	40CBV-PB4-04.....	50
20PPV-PE4-04MALD.....	44	40AC-S9-04.....	46	40CBV-PB4-06.....	50
20PPV-PE10-04.....	44	40ACV-PB2-04.....	48	40CBV-PB9-04.....	49
20PPV-PE19-04GSPNMALD.....	44	40ACV-PB2-05.....	48	40CBV-PB9-06.....	49
20PPV-SE1-02.....	41	40ACV-PB2-06.....	48	40CBV-PB10-04.....	50
20PPV-SE1-04.....	41	40ACV-PB3-04.....	50	40CBV-PB10-06.....	50
20PPV-SE1-04MALD.....	41	40ACV-PB3-05.....	50	40CBV-S35297.....	64
20PPV-SE2-01.....	41	40ACV-PB4-04.....	50	40CBV-SB1-04.....	48
20PPV-SE2-02.....	41	40ACV-PB4-06.....	50	40CBV-SB1-04BSPT.....	48
20PPV-SE2-02MALD.....	41	40ACV-PB8-04.....	50	40CBV-SB1-06.....	48
20PPV-SE2-04MALD.....	41	40ACV-PB9-04.....	48	40CBV-SB1-06BSPT.....	48
20PPV-SE3-01.....	43	40ACV-PB9-06.....	48	40CBV-SB2-04.....	48
20PPV-SE3-02.....	43	40ACV-PB10-06.....	50	40CBV-SB2-06.....	48
20PPV-SE3-02MALD.....	43	40ACV-PB17-04.....	49	40CBV-SB3-04.....	49
20PPV-SE3-04.....	43	40ACV-PB18-04.....	50	40CBV-SB3-06.....	49
20PPV-SE3-04GSPNMALD.....	43	40ACV-SB1-04.....	48	40CBV-SB8-04.....	49
20PPV-SE3-04MALD.....	43	40ACV-SB1-04BSPT.....	48	40CBV-SB9-06.....	48
20PPV-SE8-04.....	43	40ACV-SB1-06.....	48	40CBV-SB12-04.....	49
20PPV-SE9-04.....	41	40ACV-SB1-06BSPT.....	48	40PP-PE2-04.....	46
20PPV-SE19-04GSPNMALD.....	43	40ACV-SB2-04.....	48	40PP-S1-04.....	46
20PPX-PE1-02.....	39	40ACV-SB2-05.....	48	40PP-S2-04.....	46
20PPX-PE4-02MALD.....	41	40ACV-SB2-06.....	48	40PP-S3-04.....	47
20PPX-PE4-04MALD.....	41	40ACV-SB3-04.....	49	40PP-S3-04MALD.....	47
30AC-S2-02.....	45	40ACV-SB3-05.....	49	40PP-S8-06.....	47

40PP-S9-06.....	46	50GP-PF5-04.....	51	60PS-S2-08BLK.....	54
40PPV-PE2-04.....	49	50GP-PF5-06.....	51	60PS-S3-08BLK.....	55
40PPV-PE2-04MALD.....	49	50GP-PF6.....	51	60PSV-PE1-06.....	56
40PPV-PE2-06.....	49	50GP-PF7-06.....	52	60PSV-PE2-08.....	56
40PPV-PE2-06MALD.....	49	50GP-S1-04.....	51	60PSV-PE3-06.....	57
40PPV-PE3-04.....	50	50GP-S5-04.....	51	60PSV-PE3-06BLK.....	57
40PPV-PE4-04.....	50	50GP-S5-06.....	51	60PSV-SE1-06.....	56
40PPV-PE4-04MALD.....	50	50GP-S7-06.....	52	60PSV-SE1-08.....	56
40PPV-PE4-06.....	50	50GPV-SF5-06.....	52	60PSV-SE2-06.....	56
40PPV-PE10-06MALD.....	50	50PPV-PE2-06.....	53	60PSV-SE2-08.....	56
40PPV-SE1-04.....	48	50PPV-PE4-04.....	53	60PSV-SE3-12BLK.....	57
40PPV-SE2-04.....	48	50PPV-PE4-06.....	53	65GP-PF1-08.....	58
40PPV-SE2-06MALD.....	48	50PPV-SE3-04.....	53	65GP-PF2-08.....	58
40PPV-SE3-04.....	49	50PPV-SE3-06.....	53	65GP-S2-12.....	58
40PPV-SE3-04MALD.....	49	50PPX-PE1-04.....	51	100AC2-M3.....	59
40PPV-SE3-06.....	49	50PPX-PE1-06.....	51	100AC-PB2-01.....	59
40PPV-SE3-06MALD.....	49	55GPV-PE2-06.....	54	100AC-PB2-02.....	59
40PPV-SE8-06MALD.....	49	55GPV-SE2-06.....	54	100AC-S2-01.....	59
40PPV-SE9-06.....	48	60PP-PE2-04.....	55	100AC-S2-M3.....	59
42AB-PB2-02.....	50	60PP-PE2-04BLK.....	55	100ACV2-M3.....	59
42AB-S3-02.....	50	60PP-PE2-08.....	55	100ACV-SB2-01.....	59
50AC-PB2-04.....	51	60PP-PE4-08.....	55	100PP2-02.....	59
50AC-PB2-06.....	51	60PP-S1-12.....	54	100PP2-M3.....	59
50AC-PB4-06.....	52	60PP-S2-06.....	54	100PP-S2-M3.....	59
50AC-PB9-04.....	51	60PP-S2-08.....	54	1040.....	22
50AC-PB17-04.....	51	60PP-S3-06.....	55	1600.....	109
50AC-S1-04.....	51	60PP-S3-08.....	55	1610.....	109
50AC-S1-06.....	51	60PPV-PE1-08.....	56	1620.....	109
50AC-S2-04.....	51	60PPV-PE1-08BLK.....	56	1630.....	109
50AC-S2-06.....	51	60PPV-PE2-04BLK.....	56	1640.....	109
50AC-S2-06LB.....	51	60PPV-PE2-06.....	56	1650.....	109
50AC-S3-04.....	52	60PPV-PE2-06BLK.....	56	1802.....	111
50AC-S3-06.....	52	60PPV-PE2-08.....	56	1820.....	110
50AC-S8-06.....	52	60PPV-PE2-12.....	56	1830.....	110
50ACV-PB1-04.....	53	60PPV-PE3-06.....	57	1840.....	110
50ACV-PB2-04.....	53	60PPV-PE4-06.....	57	1850.....	110
50ACV-PB2-06.....	53	60PPV-PE4-08.....	57	1860.....	110
50ACV-PB4-04.....	53	60PPV-PE22-08BLK.....	57	2040.....	22
50ACV-PB4-06.....	53	60PPV-SE1-06.....	56	2050.....	22
50ACV-SB1-06.....	52	60PPV-SE1-08.....	56	3040.....	22
50ACV-SB2-04.....	52	60PPV-SE1-08BLK.....	56	3050.....	23
50ACV-SB2-06.....	52	60PPV-SE2-06.....	56	3060.....	23
50ACV-SB3-04.....	53	60PPV-SE2-06BLK.....	56	4040.....	21
50ACV-SB3-06.....	53	60PPV-SE2-08.....	56	4050.....	23
50BAC-S1-04.....	51	60PPV-SE2-08BLK.....	56	4060.....	23
50BAC-S2-05LB.....	51	60PPV-SE3-06.....	57	5050.....	21
50BAC-S2-06LB.....	51	60PPV-SE3-08.....	57	5060.....	23
50BAC-S8-04.....	52	60PS-PE1-08.....	55	6060.....	21
50BAC-S8-06.....	52	60PS-PE4-06.....	55	16210.....	109
50BAC-S9-06LB.....	51	60PS-PE22-06.....	55	16220.....	109
50BACV-SB3-05.....	53	60PS-S2-08.....	54	16230.....	109

16240.....	109	BDMK	115	CPAX150	83
16250.....	109	BDML220.....	114	CPAX300	84
16410.....	109	BDML420.....	114	CPAX400	84
16420.....	109	BDMM6.....	115	CPN75	84
16430.....	109	BDMR210.....	114	CPT90.....	85
16445.....	109	BDMR220.....	114	CPT100.....	85
16450.....	109	BDMR230.....	114	CPT110.....	85
18210.....	110	BDMR240.....	114	CPX150.....	84
18220.....	110	BDMR445.....	114	Custom Quick Connect Solutions.....	65
18230.....	110	BDMT210.....	114	CYLINDRAFlow™ Manifolds.....	88
18240.....	110	BDMT220.....	114	D.....	103
18410.....	110	BDMT230.....	114	DC.....	22
18420.....	110	BDMT410.....	114	DCV114	69
18430.....	110	BDMT420.....	114	DCV115	69
18445.....	110	BDMT430.....	114	DCV118	69
AA.....	21	BDMX.....	115	DCV125	69
ABR004	107	BioClamp®	80	DD.....	21
ABR007	107	BioProcessing Check Valves.....	77	Divert™ Stopcocks.....	72
ABR013	107	BioProcessing Fittings.....	74	Double Check Valves	69
ABSML.....	17	BioValve®.....	81	Elbow Connectors.....	24, 96
AC.....	22	Blood Pressure Fittings	33, 100	Enteral Connectors	33
AD	22	BPA025.....	101	ENTFTC.....	33
AF7500753.....	116	BPA035.....	101	ENTM230	33
B.....	103	BPC240	101	FCFFM-017	73
Bag Ports.....	74	BPCL220	101	FCFFM-020	73
Barb Dimensions.....	120	BPCL240	101	FCFFMR-007	73
Barb Performance.....	122	BPCL250	101	FCFM-006.....	73
BDF16.....	115	BPF230.....	100	FCFMR-001	73
BDF18.....	115	BPF240.....	100	FCHPFFMR-003.....	73
BDFM6.....	115	BPF Series Properties & Performance	127	FCHPFFMR-002.....	73
BDFS.....	115	BPLF240.....	100	FCLBFFMR-1A-003	73
BDJ05.....	113	BPLM230	100	FCLBFMR-001	73
BDJ06.....	113	BPLM240	100	FCVFFM-008	34, 73
BDJ07.....	113	BPM013.....	33, 101	FCVFM-001	34, 73
BDJ08.....	113	BPM025.....	33, 101	FLB035.....	119
BDJ09.....	113	BPM035.....	33, 101	FLB055.....	119
BDJ10.....	113	BPM240.....	33, 101	FLBP	119
BDJ11.....	113	BPMB230.....	33, 101	FMD5P670-001	88
BDJ13.....	113	BSFTLL.....	18	FSLLR	12, 15
BDJ14.....	113	BSMLRL.....	17	FTL10	14
BDJ15.....	113	Build-a-Part Fittings	112	FTL20	14
BDJ16.....	113	C.....	103	FTL30	14
BDJ17.....	113	CC.....	21	FTL210	14
BDJ18.....	113	CCLR.....	19, 31	FTL220	14
BDJ19.....	113	CCR.....	19	FTL230	15
BDJ20.....	113	CF229	101	FTL240	15
BDJ21.....	113	CF230	101	FTLB210.....	19
BDJ22.....	113	CF494	96	FTLB220.....	19
BDM16.....	115	Check Valves.....	66	FTLB230.....	19
BDM18.....	115	Chemical Resistance of Resin	128	FTLC	15
BDMFTLL.....	114	CPAN75	83	FTLE	15

FTLL004.....	13	KL410.....	104	LT878.....	15
FTLL007.....	13	KL420.....	104	Luers.....	10
FTLL013.....	13	KL430.....	104	M5210.....	108
FTLL025.....	14	KN.....	106	M5220.....	108
FTLL035.....	14	KP.....	106	M5230.....	108
FTLL055.....	14	KT210.....	105	M5240.....	108
FTLL210.....	13	KT220.....	105	M6210.....	108
FTLL220.....	13	KT230.....	105	M6220.....	108
FTLL230.....	13	KT410.....	105	M6230.....	108
FTLL240.....	14	KT420.....	105	M6240.....	108
FTLL250.....	14	KT430.....	105	M6250.....	108
FTLL360.....	14	L10.....	24	M6410.....	108
FTLL410.....	13	L20.....	24	M6420.....	108
FTLL420.....	13	L30.....	24	M6430.....	108
FTLL430.....	13	L40.....	24	M6445.....	108
FTLL445.....	14	L50.....	24	M6450.....	108
FTLL450.....	14	L60.....	24	Manifold Connectors.....	29, 99
FTLLB210.....	18	L070.....	96	MLB035.....	119
FTLLB220.....	18	L070/055.....	96	MLB055.....	119
FTLLB230.....	18	L080.....	96	MLB065.....	119
FTLLBMLRL.....	18	L080/070.....	96	MLBC8.....	119
FTLLC.....	15	L090.....	96	MLBP.....	119
FTLLE.....	15	L100.....	96	MLRL004.....	12
FTLLP.....	16	L100/080.....	96	MLRL007.....	12
FTLLSB004.....	14	L110.....	96	MLRL013.....	12
FTLLSB007.....	14	L110/100.....	96	MLRL025.....	12
FTLLSB013.....	14	L210.....	24	MLRL035.....	12
FTLP.....	16	L220.....	24	MLRL055.....	12
FTLT.....	15	L220/210.....	25	MLRLB210.....	19
G40MPGR-TF150.....	93	L230.....	24	MLRLB220.....	19
G40RX-PX-0400.....	94	L230/210.....	25	MLRLB230.....	19
G424TRX-0300.....	93	L230/220.....	25	MLRLC.....	15
Gaskets.....	93	L410.....	24	MLRLP.....	16
GM4749TRX-0600.....	94	L420.....	24	MLSL007.....	12
GMN75.....	93	L430.....	24	MLSL013.....	12
GMN450.....	93	L430/420.....	25	MLSLP.....	16
GMX150.....	93	L440.....	24	MQCF230.....	60
GMX455.....	93	L6110.....	96	MQCF240.....	60
Intravascular Fittings.....	34	Large Tube Fittings.....	95	MQCF250.....	60
ISO 80369 Compliant Connectors.....	32	LC34.....	15	MQCMF230.....	60
K210.....	103	LC78.....	15	MQCMF240.....	60
K220.....	103	LE87.....	15	MQCMF250.....	60
K230.....	103	LE7220.....	15	MQCRM230.....	60
K240.....	103	LE7230.....	15	MQCRM240.....	60
K410.....	103	LLDPE02-1019M.....	116	MQCRM250.....	60
K420.....	103	LLDPE02-2031M.....	116	MSL004.....	13
K430.....	103	LLDPE02-3031M.....	116	MSL007.....	13
K445.....	103	LNS.....	19, 31	MSL013.....	13
KFTLL.....	18	LP4.....	16	MSL035.....	13
KL210.....	104	LP34.....	16	MTLCS.....	15
KL230.....	104	LT787.....	15	MTLL004.....	11

MTLL007	11	N090	95	NVFMLLS-001	71
MTLL013	11	N090/055	95	NVFMMLPC	71
MTLL025	11	N090/070	95	NVFMMLPCB	71
MTLL035	11	N100	95	NVfy42S-001	71
MTLL055	11	N100/080	95	NVfy401CP	71
MTLL210	11	N110	95	NVfy401PC	71
MTLL220	11	N110/100	95	NVM41S-001	71
MTLL230	11	N210	21	Opposing Barb Ports	78
MTLL240	11	N220	21	Panel Mount Instructions	127
MTLL250	11	N220/210	22	PharmaLok™ Clamps	82
MTLL360	11	N230	21	PIP10	30
MTLL410	11	N230/210	22	PIP20	30
MTLL420	11	N230/220	22	PIP30	30
MTLL430	11	N410	21	PIP40	30
MTLL445	11	N420	21	PIP50	30
MTLL450	11	N420/410	22	PIP60	30
MTLLP	16	N430	21	PIP070	99
MTLLPV-6005	16, 34	N430/410	22	PIP080	99
MTLP	16	N430/420	22	PIP210	30
MTLS210	13	N440	21	PIP220	30
MTLS220	13	N670	95	PIP230	30
MTLS230	13	N670/630	95	PIP240	30
MTLS240	13	N670/655	95	PIP670	99
MTLSP	16	N680	95	PIP680	99
N004	21	N680/655	95	PIP6100	99
N007	21	N680/670	95	PIP6110	99
N007/004	22	N690	95	Plug Connectors	30, 99
N013	21	N690/655	95	PM4N	63
N013/004	22	N6100	95	PMK210	31
N013/007	22	N6100/670	95	PMK220	31
N025	21	N6100/680	95	PMKN	19, 31
N025/004	22	N6110	95	PMS230	31
N025/007	22	N6110/680	95	PMS230-210	31
N025/013	22	N6110/6100	95	PMSN	19, 31, 101
N035	21	N6150	95	PVCA1190035	117
N035/007	22	N6150/6110	95	PVCA1190049	117
N035/013	23	Needlefree Swabable Valves	70	PVCA1190126	117
N035/025	23	NEFC-50	34	PVCA1190189	117
N055	21	NEFC-8012	34	PVCA1190203	117
N055/013	23	NEFCV-50	34	PVCA1190280	117
N055/025	23	NEFCV-9010	34	PVCA1190357	117
N055/035	23	NEFE21-9010	34	Quick Connect Couplings	36
N065	21	NEFE31-9010	34	Quick Connect Performance Ratings	123
N065/035	23	NEME31-9010	34	RB01	114
N065/055	23	NEMP-50	34	Resin Sterilization Stability	130
N070	95	Neuraxial Connectors	34	RMLLR	114
N070/013	95	NVF13VPC	70	RQCF655	61
N070/055	95	NVFBGPC	71	RQCF670	61
N080	95	NVFBV60PC	71	RQCFC	61
N080/055	95	NVFMLLCP	71	RQCFLC	61
N080/070	95	NVFMMLPC	71	RQCM655	61

RQCM670.....	61	SCV67230/220.....	68	SFMX6150.....	90
RQCMP.....	61	SCV67230/ML.....	68	SFMXC.....	92
RQXF670.....	61	SDAFCNPS.....	87	SFTL.....	18
RQXF680.....	61	SDAM655NPS.....	86	SFTLL.....	18
RQXFC.....	61	SDAM670NPS.....	87	SILC7001422.....	117
RQXM670.....	61	SDAM680NPS.....	87	SILC7001657.....	117
RQXM680.....	61	SDAMPNPS.....	87	SILC7001839.....	117
RQXMP.....	61	SDAVF655NPS.....	86	SILPG7021041.....	117
S10.....	106	SDAVF670NPS.....	87	SILPG7021042.....	117
S20.....	106	SDAVF680NPS.....	87	SILPG7021043.....	117
S40.....	107	SDAVM655NPS.....	86	SILPG7021044.....	117
S50.....	107	SDAVM670NPS.....	87	SMTLL.....	17
S220.....	106	SDAVM680NPS.....	87	SP.....	107
S230.....	106	SFBP630.....	75	Spaulding™ Aseptic Disconnects.....	86
S240.....	107	SFBP635/635.....	78	Straight Connectors.....	21, 95
S250.....	107	SFBP655.....	75	T10.....	25
S410.....	106	SFBP655/655.....	78	T013.....	26
S420.....	106	SFBP670.....	75	T20.....	25
S430.....	107	SFBP670/670.....	78	T30.....	25
S445.....	107	SFBP680.....	75	T40.....	26
S450.....	107	SFBP680/680.....	78	T055.....	26
Sanitary Fittings.....	89	SFBP6100.....	75	T60.....	26
SBLF013.....	62	SFBP6100/6100.....	78	T070.....	97
SBLF035.....	62	SFBP6110.....	75	T070/055.....	97
SBLM013.....	62	SFBPF1.....	76	T080.....	97
SBLM035.....	62	SFBPF3.....	76	T080/055.....	97
SBLMFBG013.....	62	SFBPF4.....	76	T080/070.....	97
SBLMFBG035.....	62	SFM2X6110.....	90	T100.....	97
SBLMFBG013.....	62	SFM2X6150.....	91	T100/080.....	97
SBLMFGB035.....	62	SFM2XC.....	92	T110.....	97
SCV67FL/220.....	68	SFM2XY.....	91	T110/100.....	97
SCV67FL/230.....	68	SFM3C.....	77	T210.....	25
SCV655U50C050.....	77	SFM3X6110.....	91	T210/220.....	26
SCV06246.....	66	SFM3XC.....	92	T210/230.....	26
SCV06252.....	66	SFM4C.....	77	T220.....	25
SCV06264.....	67	SFM100/SFM075.....	92	T220/210.....	26
SCV06265.....	67	SFM150/SFM075.....	92	T220/230.....	26
SCV06308.....	67	SFM150/SFM100.....	92	T220R210.....	26
SCV06329.....	67	SFM200/SFM075.....	92	T230.....	26
SCV06397.....	67	SFM200/SFM150.....	92	T230/210.....	27
SCV06398.....	67	SFMN630.....	89	T230/220.....	27
SCV08053.....	67	SFMN655.....	89	T230R210.....	27
SCV10090.....	67	SFMN670.....	89	T230R220.....	27
SCV17090.....	67	SFMN680.....	89	T250.....	26
SCV21053.....	67	SFMN6100.....	89	T360/220.....	27
SCV22050.....	67	SFMNC.....	92	T360/230.....	27
SCV23050.....	68	SFMX655.....	90	T360/250.....	27
SCV67220.....	68	SFMX670.....	90	T410.....	25
SCV67220/230.....	68	SFMX680.....	90	T410/420.....	26
SCV67220/ML.....	68	SFMX6100.....	90	T410/430.....	26
SCV67230.....	68	SFMX6110.....	90	T420.....	25

T420/410	26	VNG300WHT	80	Y210.....	28
T420R410.....	26	VNG400WHT	80	Y220.....	28
T430.....	26	VNG600WH.....	80	Y230.....	28
T430/410	27	VNG800WH.....	80	Y240.....	28
T430/420	27	VPM1060200N	119	Y250.....	28
T430R410.....	27	VPM1080303N	119	Y260.....	28
T670.....	97	VPM2930601N	119	Y410.....	28
T670/655	97	VPS3901074N	119	Y420.....	28
T680.....	97	VPS5069200N	119	Y430.....	28
T680/655	97	VPS5401001N	68	Y450.....	28
T680/670	97	VPS5401020N	68	Y460.....	28
T690.....	97	VPS5401036SN	68	Y630/655.....	98
T6100	97	VPS5401068N	68	Y655/670.....	98
T6100/670	97	X10	103	Y670.....	98
T6100/680	97	X210.....	103	Y670/680.....	98
T6110	97	X220.....	103	Y680.....	98
T6110/6100.....	97	X230.....	103	Y690.....	98
T6150	97	X240.....	103	Y6100.....	98
T6150/6100.....	97	X410.....	103	Y6100/6110	98
T6150/6110	97	X420.....	103	Y6110.....	98
Tapered Seal.....	118	X430.....	103	Y6150.....	98
Technical Information	120	X445.....	103	Y Connectors	28, 98
Tee Connectors.....	25, 97	XFTL.....	18		
Threaded Connectors.....	102	XFTLL.....	18		
TR30/50-PK5.....	35, 79	XL210.....	104		
TR55/70-PK5.....	35, 79	XL220.....	104		
TR80/100-PK5.....	35, 79	XL230.....	104		
Trademarks.....	131	XL410.....	104		
TSC2F210	118	XL420.....	104		
TSC2FB230.....	118	XMTLL	17		
TSC2M210	118	XN	106		
TSC2MP.....	119	XQCLM770.....	63		
Tube Clamps	85	XQCM755.....	63		
Tube Fittings.....	20	XQCM770.....	63		
Tubing.....	116	XQCVM755.....	63		
Tubing Retainers.....	35, 79	XQCVM765.....	63		
U10	31	XQCVM770.....	63		
U20	31	XQSVF755	63		
U30	31	XQSVF765	63		
UR00-1031C	117	XQSVF770	63		
UR00-1031M	117	XT210	105		
UR00-2047C	117	XT410	105		
UR00-2047M	117	XT420	105		
UR00-3062C	117	XT430	105		
UR00-3062M	117	Y013.....	28		
VBV0500NW	81	Y055.....	28		
VBV1000NW	81	Y070.....	98		
VLP4	16	Y080.....	98		
VNG075WHT	80	Y090.....	98		
VNG150WHT	80	Y100.....	98		
VNG200WHT	80	Y110.....	98		

About Nordson MEDICAL

Nordson MEDICAL is a global integrated solutions partner with more than 30 years of experience in design, engineering, and manufacturing of complex medical devices and components. Nordson MEDICAL specializes in components and services used in interventional and minimally invasive surgical products including catheters, balloons, extrusions, polyimide and composite tubing, heat shrink tubing, reinforced shafts, cleanroom injection molding, and finished device assembly and packaging.

Visit Nordson MEDICAL at nordsonmedical.com



©2024 Nordson MEDICAL. All rights reserved. PCV032 Rev. A 2024-01

Value Plastics, Inc.
dba Nordson MEDICAL
805 West 71st Street
Loveland, CO 80538, USA

Phone: (970) 267-5200
Toll Free: (888) 404-5837

orders@nordsonmedical.com
www.nordsonmedical.com